



FEATURES

- Outputs: 4 x channels
- BUS+SEQUENCER+FADER+DIMMER+DRIVER
- Input: DC 12/24/48 Vdc
- BUS Command: DMX512+RDM
- LOCAL Command: 4x N.O. push button (with or without memory), 0-10V, 1-10V
- Controls: dimmer, dim to warm, tunable white, RGB, RGBW
- Current variant from 350ma to 2,8A
- Typical efficiency > 95%
- Adjusting the brightness up to completed off (Dim to dark)
- Level minimum of brightness: 0.1% (1% in push)
- D-PWM Modulation
- Adjusting D-PWM frequency: 300 / 600 / 1200 Hz
- Adjusting output curve: Linear / Quadratic / Exponential
- Soft start and soft stop
- Soft dimming regulation
- Master / Slave Function (DMX variant)
- Extended temperature range
- 100% Functional test

Application

Projects for architects, OEM, lighting designers, interior designers, interior designers.
 Generic lighting, white and dynamic white furniture lighting, architectural lighting, high colour rendering light and RGB and RGB+W scenes.

CONSTANT CURRENT VARIANT (common anode)

CODE	Supply voltage	Output	Channel	Command
4ch-LED-DIMMER-DMX-C	12-48V DC	1x1000-2800°	4	DMX
		4x250-700mA		Button N.A. / 0-10 / 1-10 / Pot 10kΩ

PROTECTIONS

		VOLTAGE VARIANT
OTP	Over temperature protection ¹	✓
OVP	Over voltage protection ²	✓
UVP	Under voltage protection ²	✓
RVP	Reverse polarity protection ²	✓
IFP	Input fuse protection ²	✓
SCP	Short circuit protection	✓
CLP	Current limit protection	✓

¹ Thermal Protection on the output channel in case of high temperature. The thermal intervention is detected by transistor (> 150°C)

² Only control logic protection

● **REFERENCE STANDARDS**

Cod	Content
EN 61347-1	Lamp control gear - Part 1: General and safety requirements
EN 55015	Limits and methods of measurement of radio disturbance characteristics of electrical lighting and similar equipment
EN 61547	Equipment for general lighting purposes - EMC immunity requirements
EN 50581	Technical documentation for the assessment of electrical and electronic products with respect to the restriction of hazardous substances
IEC 60929-E.2.1	Control interface for controllable ballasts - control by d.c. voltage - functional specification
ANSI E 1.3	Entertainment Technology - Lighting Control Systems - 0 to 10V Analog Control Specification
ANSI E1.11	Entertainment Technology - USITT DMX512-A - Asynchronous Serial Digital Data Transmission Standard for Controlling Lighting Equipment and Accessories
ANSI E1.20	Entertainment Technology-RDM-Remote Device Management over USITT DMX512 Networks

● **TECHNICAL SPECIFICATIONS**

Feature		Constant Current Variant										
Supply voltage		DC min: 10.8 Vdc ... max: 52,8 Vdc										
Output voltage		min: Vin/4 – max: Vin-0,9V										
Input Current ³		max 2,8 A										
Output current		@ ch						Total				
		4 x max 700 mA						// 1 x max 2,8A				
Nominal power @ channel Single output	Current [mA]	250	300	350	400	450	500	550	600	650	700	
	@12V	3W	3,6W	4,2W	4,8W	5,4W	6W	6,6W	7,2W	7,8W	8,4W	
	@24V	6W	7,2W	8,4W	9,6W	10,8W	12W	13,2W	14,4W	15,6W	16,8W	
	@48V	12W	14,4W	16,8W	19,2W	21,6W	24W	26,4W	28,8W	31,2W	33,6W	
Total nominal power Parallel output	Current [mA]	250	300	350	400	450	500	550	600	650	700	
	@12V	12W	14,4W	16,8W	19,2W	21,6W	24W	26,4W	28,8W	31,2W	33,6W	
	@24V	24W	28,8W	33,6W	38,4W	43,2W	48W	52,8W	57,6W	62,4W	67,2W	
	@48V	48W	57,6W	67,2W	76,8W	86,4W	96W	105,6W	115,2W	124,8W	134,4W	
Power loss in stand by mode		< 500mW										
Type of Load		R – L – C										
Thermal shutdown ⁴		150 °C										
D-PWM dimming frequency		300Hz – 600Hz – 1200Hz										
D-PWM resolution		16 bits										
D-PWM range		0,1% ÷ 100%										
Storage Temperature		min: -40 max: +60 °C										
Ambient Temperature		min: -40 max: +60 °C										
Protection grade		IP10										
Wiring		Buttons & Bus: 1.5 mm ² solid - 1 mm ² stranded - 30/14 AWG Power & Leds: 2.5mm ² solid - 1.5mm ² stranded - 30/12 AWG										
Mechanical dimensions		72 x 92 x 62 mm - DIN RAIL 4mod.										
Package dimensions		124 X 92 X 71 mm										
Casing material		Plastic										
Weight		125g										

³ Maximum value, depending on ventilation conditions

⁴ The Temperature Protection, in case of high temperature, is detected by transistor (> 150°C) and is only on the output channel

• INSTALLATION

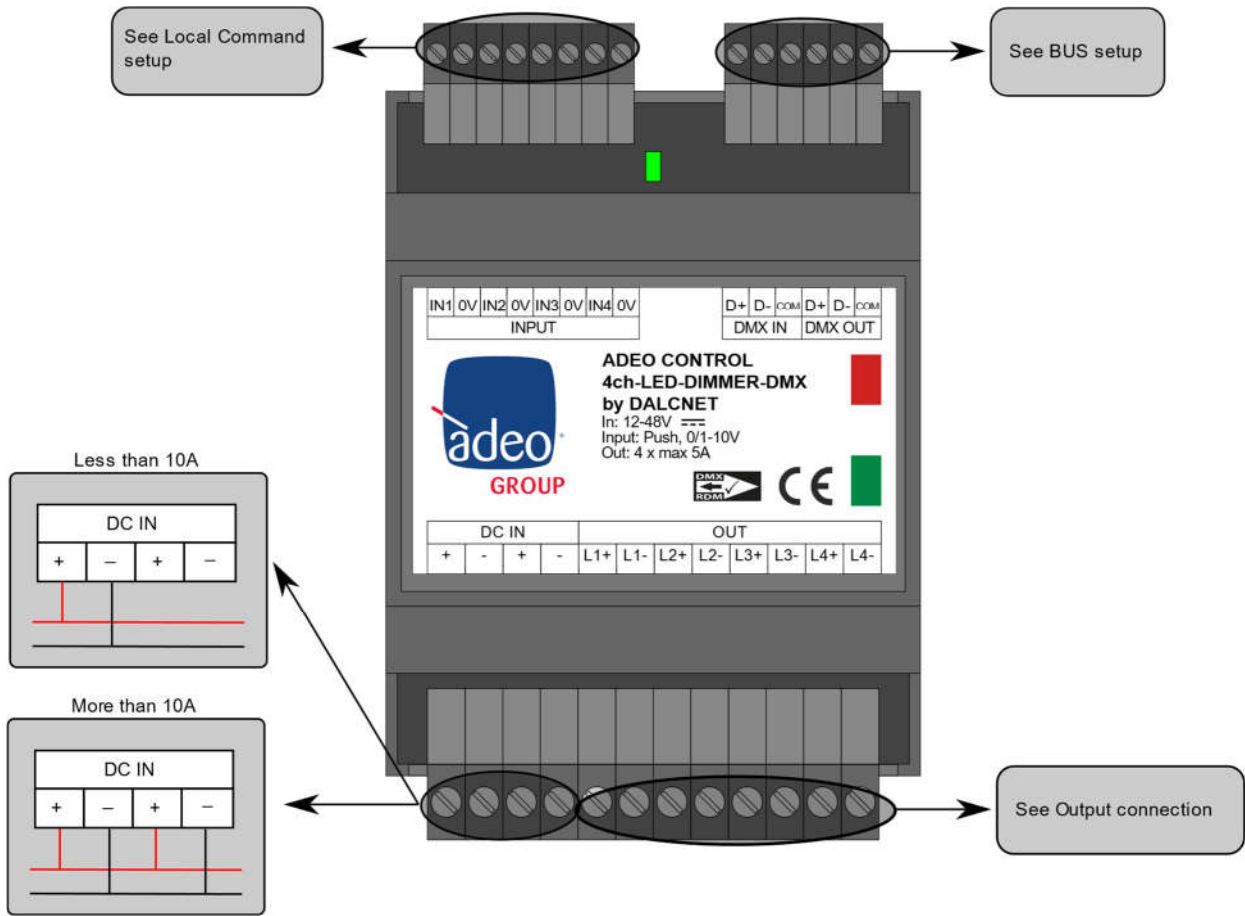

Opening the cover

For the Dip-switch and selectors configuration it is necessary to pull up the cover of the device. See the picture.

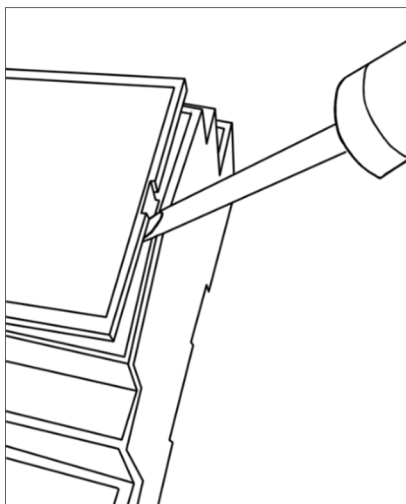

Mechanical Dimensions

(without connectors)

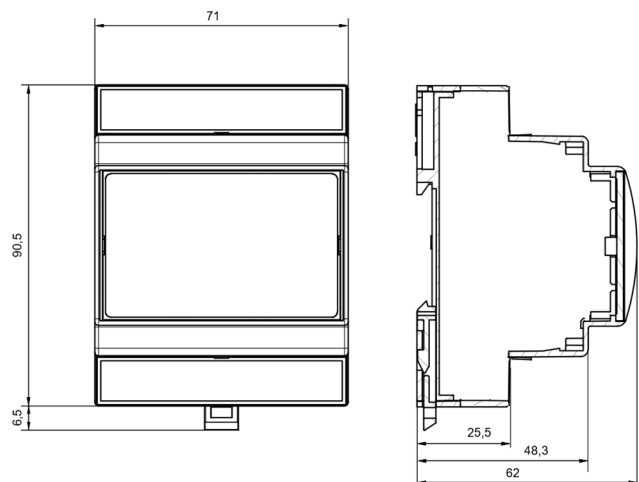

● TECHNICAL NOTES:

Installation:

- Installation and maintenance must be performed only by qualified personnel in compliance with current regulations.
- The product must be installed inside an electrical panel protected against overvoltage's.
- The product must be installed in a vertical or horizontal position with the cover / label upwards or vertically; other positions are not permitted. It is not permitted the bottom-up position (with the lower face plate / label).
- Keep separate the 230V circuits (LV) and not SELV circuits from safety extra low voltage (SELV) and all connections for this product. It's absolutely forbidden to connect, for any reason, directly or indirectly, the 230V mains voltage to the bus or to other parts of the circuit.

Power supply:

- For power supply use only SELV power supplies with limited current and short circuit protection, and of appropriately sized power. In case of power supplies provided with an earth terminal, ALL protective earthing points (PE = Protection Earth) must be connected to a valid protection earth.
- The connection cables between the power source and the product must be sized properly and should be isolated from any wiring or live parts not SELV. Use double insulated cables.
- In the event of higher than 10A total output current to plug into both power input pairs "V +" and "V-".
- Dimension the power supply for the load connected to the device. If the power supply is oversized compared to the maximum running current, insert a protection against over-current between the power supply and the device.
- For the constant current outputs, the maximum voltage drop of the LED module (V_f) must be less than the supply voltage of at least 5V.

Commands:

- The length of the connecting cables between the local controls (push button, 0-10V, 1-10V, potentiometer, or other) and the product must be less than 10m; the cables must be sized properly and should be isolated from any wiring or live parts not SELV. Use double insulation shielded and twisted cables.
- The length and type of the connection cables at the BUS (DMX512, Ethernet, or other) use cables as per specification of the respective protocols and regulations and they should be isolated from every wiring or parts at voltage not SELV. It is suggested to use double insulated shielded and twisted cables.
- All devices and related control signals to the bus (DMX512, Ethernet or other) and to the local controls (push button, 0-10V, 1-10V, potentiometer, or other) must be SELV (connected devices must be SELV or otherwise provide a SELV signal).

Outputs:







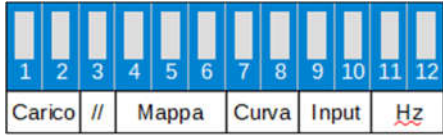

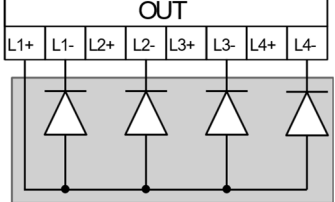
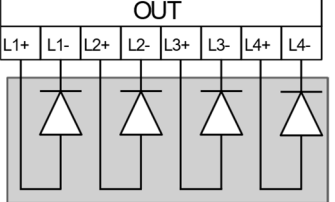

- The length of the connection cables between the product and the LED module must be dimensioned correctly and they should be isolated from every wiring or parts at voltage not SELV. It is suggested to use double insulated shielded and twisted cables.

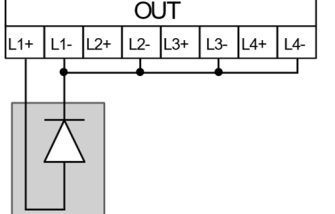
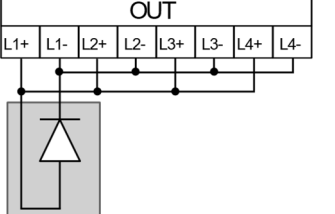
• **SET UP AND INSTALLATION**

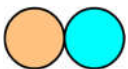
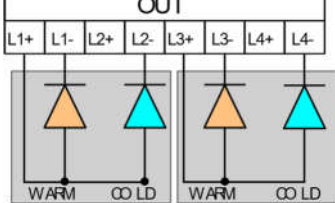
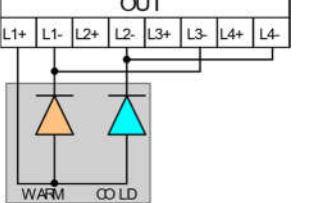
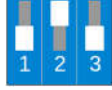
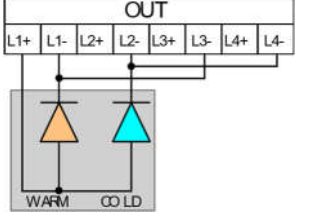
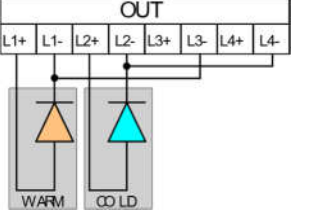
A 12-way dip-switch (under the cover) can provide a rich set of possible configurations:
 Note: Factory positions = all OFF

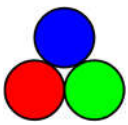
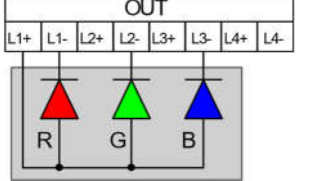
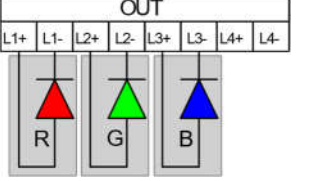

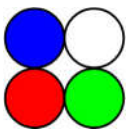
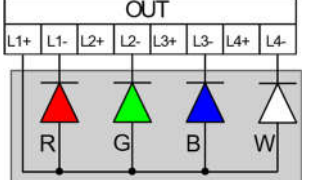
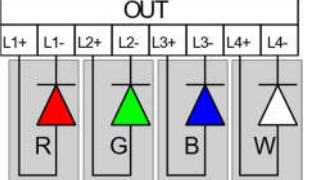



Function		Switches from 1 to 2 Switch 3 Switches from 4 to 6 Switches from 7 to 8 Switches from 9 to 10 Switches from 11 to 12	Load typer Parallel Outputs Map Curve Input type Output frame rate
----------	---	---	---

1. Select Load Type and Parallel Out depending on output connections: Switches from 1 to 2 and Switch 3

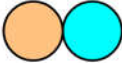
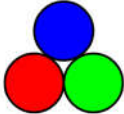
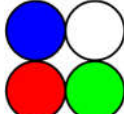
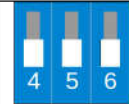
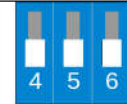
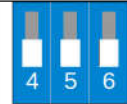

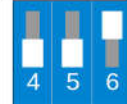
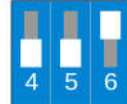
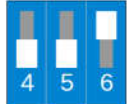
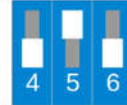
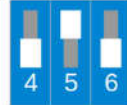
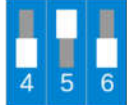
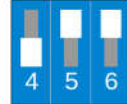
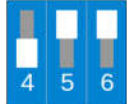
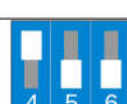
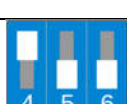
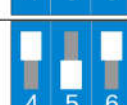
Load Type	Description	Connections (total current 0 - 10A max)	Connections (total current 0 - 20A max)	Settings
	White, up to 4 loads			
	White, parallel outputs with increased current (Macro dimmer)			
	Tunable White, up to 2 loads			
	Tunable White, parallel output pairs with increased current			
	RGB			
	RGBW			

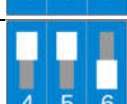
Note: Set the "Select Map" according to the connected load and the function you want. See "Map Setting" page 6.





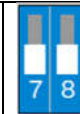
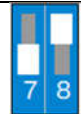

2. Select Map: Switches from 4 to 6

White load 		Tunable White Load 		RGB Load 		RGBW Load 	
Dimmer		Dimmer		Dimmer		Dimmer	
		Dim to warm		Dim to warm		Dim to warm	
		Tunable White		Tunable White		Tunable White	
				Smart HSV Intensity, temperature correction, colour hue & rotation, saturation and strobe		Smart HSV Intensity, temperature correction, colour hue & rotation, saturation and strobe	
				RGB		RGB Convert RGB → RGBW	
				RGBW Convert RGBW → RGB		RGBW	
				Master+RGB+Strobe		Master+RGB+Strobe Convert RGB → RGBW	
				Master+RGBW+Strobe Convert RGBW → RGB		Master+RGBW+Strobe	

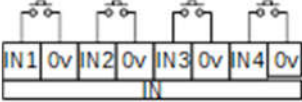

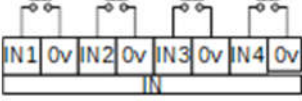
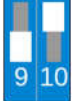
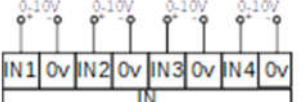
3. Select Dimming Curve: Switches from 7 to 8

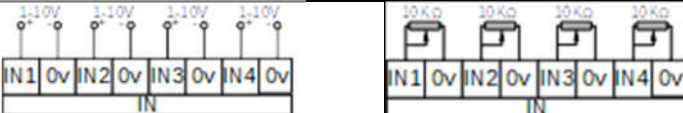
Default (by bus type)		Quadratic		Exponential		Linear	
-----------------------	---	-----------	---	-------------	---	--------	---

4. Select Local Input Type: Switches from 9 to 10





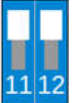





In Type	Description	Connections	Settings
Push	N.O. Push button, NO Memory		
0-10V	N.O. Push button, NO Memory		
1-10V	Analogic 0-10V		
	Analogic 1-10V & Potentiometer		

5. Set Output Frequency: Switches from 11 to 12



300Hz		600Hz		1200 Hz		Reserved	
-------	---	-------	---	---------	--	----------	---

• **Output Current Regulation**

To set the Trimmer it is necessary to open the front panel of the device. See figure pag5.









	Trimmer Setting	Current channel value		Trimmer Setting	Current channel value
Position 1		250mA	Position 6		500mA
Position 2		300mA	Position 7		550mA
Position 3		350mA	Position 8		600mA
Position 4		400mA	Position 9		650mA
Position 5		450mA	Position 10		700mA

• **Local commands functionality according to the selected Map**









Load Type	Map	IN1	IN2	IN3	IN4
 White up to 4 loads	Dimmer	DIM1 	DIM2 	DIM3 	DIM4 
 White Parallel outs	Dimmer	Dimmer 			
 Tunable white Up to 2 loads	Dimmer	Dim1 		DIM2 	
 Tunable white Parallel outs	Dimmer	Dimmer 			
 Tunable white Up to 2 loads	DIM To Warm	DIM1 To Warm 		DIM2 To Warm 	
 Tunable white Parallel outs	DIM To Warm	Dimmer To Warm 			
 Tunable white Up to 2 loads	Tunable White	Dim1 	CCT1 	Dim2 	CCT2 
 Tunable white Parallel outs	Tunable White	Dimmer 	CCT 		
 RGB & RGBW	Dimmer	Dimmer 			
 RGB & RGBW	Dim to Warm	Dimmer To Warm 			
 RGB & RGBW	Tunable White	Dimmer 	CCT 		
 RGB & RGBW	Smart HSV	Dimmer 	CCT 	Colour 	Saturation 
 RGB & RGBW	RGB	Red 	Green 	Blue 	
 RGB & RGBW	RGBW	Red 	Green 	Blue 	White 
 RGB & RGBW	MRGB	Red 	Green 	Blue 	
 RGB & RGBW	MRGBW+	Red 	Green 	Blue 	White 

• **Local Inputs**

Available Functions: N.O. PUSH BUTTON memory / N.O. PUSH BUTTON no memory:

	<p>Dimmer Dim the light following the selected dimming curve, keeping a constant colour temperature. Soft Turn On with 200ms fade time, Soft Turn Off with 1s fade time. CLICK: Turn ON/OFF light. Double Click: Turn On light at 100% Long pressure (>1s) from OFF: Turn on at 1% (Nighttime) Long pressure (>1s) from ON: Dimmer UP/DOWN</p>												
	<p>Dim to Warm Dim the light following the selected dimming curve. The colour temperature increase with intensity. Soft Turn On with 200ms fade time, Soft Turn Off with 1s fade time. CLICK: Turn ON/OFF light. Double Click: Turn On light at 100% Long pressure (>1s) from OFF: Turn on at 1% (Nighttime) Long pressure (>1s) from ON: Dimmer UP/DOWN</p>												
	<p>CCT: Colour Correction Temperature / White Balance - Tunable White load: change the colour temperature, keeping a constant intensity. Neutral white is 50% cold + 50% warm. - RGB load: change the equivalent colour temperature. Neutral white is an equal value to R, G, B. - RGBW load: balance the white from the white output to the composite RGB output. Neutral white is 50% white + 50% R+G+B. Double Click: Neutral white Long pressure (>1s): Change Colour Temperature UP/DOWN (Cold↔Warm or White↔R+G+B).</p>												
	<p>Colour rotation and selection Change the colour or colour rotation speed. CLICK: Toggle between white and colours. Double Click: Maximum saturation - Vivid Colours. Long pressure (>1s) from white: Minimum saturation - Pastel Colours. Long pressure (>1s) from colour: Change the saturation value.</p>	<table border="1"> <thead> <tr> <th>Rotation Speed</th> <th>Strobo pulse</th> </tr> </thead> <tbody> <tr> <td>6 Seconds</td> <td>10 Flashes/sec.</td> </tr> <tr> <td>30 Seconds</td> <td>5 Flashes/sec.</td> </tr> <tr> <td>6 Minute</td> <td>2 Flashes/sec.</td> </tr> <tr> <td>30 Minute</td> <td>1 Flashes/sec.</td> </tr> </tbody> </table>	Rotation Speed	Strobo pulse	6 Seconds	10 Flashes/sec.	30 Seconds	5 Flashes/sec.	6 Minute	2 Flashes/sec.	30 Minute	1 Flashes/sec.	
Rotation Speed	Strobo pulse												
6 Seconds	10 Flashes/sec.												
30 Seconds	5 Flashes/sec.												
6 Minute	2 Flashes/sec.												
30 Minute	1 Flashes/sec.												
	<p>Colour saturation: Change the colour saturation: vivid colours ↔ pastel colours CLICK: Toggle between white and colours. Double Click: Maximum saturation - Vivid Colours. Long pressure (>1s) from white: Minimum saturation - Pastel Colours. Long pressure (>1s) from colour: Change the saturation value.</p>												
	<p>Red: linear change red channel. CLICK: Turn ON/OFF channel. Double Click: Turn On channel at 100% Long pressure (>1s) from OFF: Turn on at 1% Long pressure (>1s) from ON: Dim UP/DOWN</p>												
	<p>Green: linear change green channel. CLICK: Turn ON/OFF channel. Double Click: Turn On channel at 100% Long pressure (>1s) from OFF: Turn on at 1% Long pressure (>1s) from ON: Dim UP/DOWN</p>												
	<p>Blue: linear change blue channel. CLICK: Turn ON/OFF channel. Double Click: Turn On channel at 100% Long pressure (>1s) from OFF: Turn on at 1% Long pressure (>1s) from ON: Dim UP/DOWN</p>												
	<p>White: linear change white channel. CLICK: Turn ON/OFF channel. Double Click: Turn On channel at 100% Long pressure (>1s) from OFF: Turn on at 1% Long pressure (>1s) from ON: Dim UP/DOWN</p>												

• Available Functions: 0-10V / 1-10V / potentiometers:

	<p>Dimmer Dim the light following the selected dimming curve, keeping a constant colour temperature Minimum intensity = 0.1%. Below 1V = Turn OFF light. 10V = Maximum intensity.</p>
	<p>Dim to Warm Dim the light following the selected dimming curve. The colour temperature increase with intensity. Minimum intensity = 0.1%. Below 1V = Turn OFF light. 10V = Maximum intensity.</p>
	<p>CCT: Colour Correction Temperature / White Balance - Tunable White load: change the colour temperature, keeping a constant intensity. Neutral white is 50% cold + 50% warm. - RGB load: change the equivalent colour temperature. Neutral white is an equal value to R,G,B. - RGBW load: balance the white from the white output to the composite RGB output. Neutral white is 50% white + 50% R+G+B. Change the colour temperature from warm (1V), to cold (10V).</p>
	<p>Colour rotation and selection Change the colour. Select a colour starting from red (1V), then yellow, green, cyan, blue, magenta and red again (10V).</p>
	<p>Colour saturation: Change the colour saturation: vivid colours ↔ pastel colours Change the saturation from white (1V), to vivid colours (10V).</p>
	<p>Red: linear change red channel. Below 1V = Turn OFF channel. 10V = Maximum intensity.</p>
	<p>Green: linear change green channel. Below 1V = Turn OFF channel. 10V = Maximum intensity.</p>
	<p>Blue: linear change blue channel. Below 1V = Turn OFF channel. 10V = Maximum intensity.</p>
	<p>White: linear change white channel. Below 1V = Turn OFF channel. 10V = Maximum intensity.</p>

• **DMX+RDM BUS SETUP**

With the DMX+RDM BUS SETUP in the “slave” condition the outputs are managed by an external DMX controller. In the “master” condition, the DMX+RDM allows the communications between devices.

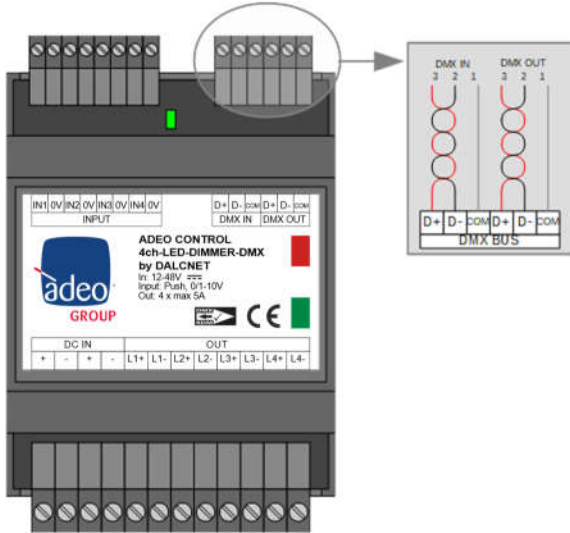

Reference Standards	
ANSI E1.11	Entertainment Technology - USITT DMX512-A - Asynchronous Serial Digital Data Transmission Standard for Controlling Lighting Equipment and Accessories
ANSI E1.20	Entertainment Technology-RDM-Remote Device Management over USITT DMX512 Networks

• **FEATUERES**

- BUS DMX512-A (NSC+RDM)
- Master/Slave

• **Onboard led:**

- In the case of bus error, the led blinks fast (2 pulsed per second).
- In the case of no bus detected, led blinks slow (1 pulse per second).
- In the case of data link active, the led stands on.

• **Relation with local commands:**





At power-up, in case of absence of connection to the BUS, local control is active
 When the BUS in detected, the control passes to the BUS. It remains to the BUS until there is signal.

In absence of signal:

- If the local command is N.O. PUSH BUTTON, the control passes to local command in the event of a N.O. push button pressure.
- If the local command is 0-10V or 1-10V the control passes immediately to the local command.

• **Addressing**

RDM or By Selectors	✓
---------------------	---

DMX	000 (default):				Address defined by RDM
	from 001		To 512		First channel address, from 1 to 512
	F00				MASTER

- **CHANNELS MAP – DMX512**

 Load Type: White - up to 4 loads

Ch.	Function	Map. Dimmer
1	Dimmer 1	
2	Dimmer 2	
3	Dimmer 3	
4	Dimmer 4	

 Load Type: White - Parallel outs (Macro dimmer)

Ch.	Function	Map. Dimmer
1	Dimmer	

 Load Type: Tunable White – up to 2 loads

Ch.	Function	Map. Dimmer
1	Dimmer 1	
2	Dimmer 2	

Ch.	Function	Map. Dim to Warm
1	Dimmer 1	
2	Dimmer 2	

Ch.	Function	Map. Tunable White
1	Dimmer 1	
2	Colour Correction 1	
3	Dimmer 2	
4	Colour Correction 2	

 Load Type: Tunable White – Parallel outs

Ch.	Function	Map. Dimmer
1	Dimmer 1	

Ch.	Function	Map. Dim to Warm
1	Dimmer 1	

Ch.	Function	Map. Tunable White
1	Dimmer 1	
2	Colour Correction	

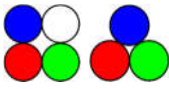





Load Type: RGB & RGBW



Ch.	Function	Map. Dimmer
1	Master Dimmer	

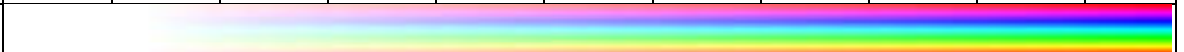



Ch.	Function	Map. Dim to Warm
1	Master Dimmer	



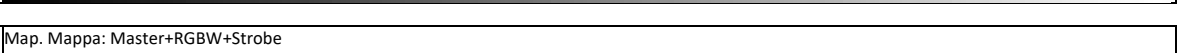

Ch.	Function	Map. Dynamic White
1	Master Dimmer	
2	Colour Correction	

Ch.	Function	Map. Smart HSV																																
1	Master Dimmer																																	
2	Colour Correction																																	
3	Hue																																	
4	Hue Rotation (rainbow) Time	<table border="1"> <tr> <td>Hue Fine</td> <td>Hold</td> <td>30min</td> <td>15min</td> <td>6min</td> <td>3min</td> <td>1min</td> <td>30s</td> <td>15s</td> <td>6s</td> <td>3s</td> </tr> <tr> <td>0 ... 15</td> <td>16 ... 25</td> <td>26 .. 51</td> <td>52 .. 76</td> <td>77 .. 102</td> <td>103..127</td> <td>128..153</td> <td>154..179</td> <td>180..204</td> <td>205..230</td> <td>231..254</td> </tr> </table>	Hue Fine	Hold	30min	15min	6min	3min	1min	30s	15s	6s	3s	0 ... 15	16 ... 25	26 .. 51	52 .. 76	77 .. 102	103..127	128..153	154..179	180..204	205..230	231..254										
Hue Fine	Hold	30min	15min	6min	3min	1min	30s	15s	6s	3s																								
0 ... 15	16 ... 25	26 .. 51	52 .. 76	77 .. 102	103..127	128..153	154..179	180..204	205..230	231..254																								
5	Saturation																																	
6	Strobo rate	<table border="1"> <tr> <td>fix</td> <td>blackout</td> <td>1fps</td> <td>2fps</td> <td>3fps</td> <td>4fps</td> <td>5fps</td> <td>6fps</td> <td>7fps</td> <td>8fps</td> <td>9fps</td> <td>10fps</td> <td>12fps</td> <td>14fps</td> <td>16fps</td> <td>fix</td> </tr> <tr> <td>0 ... 15</td> <td>16 ... 31</td> <td>32 ... 47</td> <td>48 ... 63</td> <td>64 ... 79</td> <td>80 ... 95</td> <td>96 ... 111</td> <td>112..127</td> <td>128..143</td> <td>144..159</td> <td>160..175</td> <td>176..191</td> <td>192..207</td> <td>208..223</td> <td>224..239</td> <td>240..254</td> </tr> </table>	fix	blackout	1fps	2fps	3fps	4fps	5fps	6fps	7fps	8fps	9fps	10fps	12fps	14fps	16fps	fix	0 ... 15	16 ... 31	32 ... 47	48 ... 63	64 ... 79	80 ... 95	96 ... 111	112..127	128..143	144..159	160..175	176..191	192..207	208..223	224..239	240..254
fix	blackout	1fps	2fps	3fps	4fps	5fps	6fps	7fps	8fps	9fps	10fps	12fps	14fps	16fps	fix																			
0 ... 15	16 ... 31	32 ... 47	48 ... 63	64 ... 79	80 ... 95	96 ... 111	112..127	128..143	144..159	160..175	176..191	192..207	208..223	224..239	240..254																			

Ch.	Function	Map. RGB
1	R	
2	G	
3	B	

Ch.	Function	Map. RGBW
1	R	
2	G	
3	B	
4	W	

Ch.	Function	Map. Mappa: Master+RGBW+Strobe																																
1	Master Dimmer																																	
2	R																																	
3	G																																	
4	B																																	
5	Strobo rate	<table border="1"> <tr> <td>fix</td> <td>blackout</td> <td>1fps</td> <td>2fps</td> <td>3fps</td> <td>4fps</td> <td>5fps</td> <td>6fps</td> <td>7fps</td> <td>8fps</td> <td>9fps</td> <td>10fps</td> <td>12fps</td> <td>14fps</td> <td>16fps</td> <td>fix</td> </tr> <tr> <td>0 ... 15</td> <td>16 ... 31</td> <td>32 ... 47</td> <td>48 ... 63</td> <td>64 ... 79</td> <td>80 ... 95</td> <td>96 ... 111</td> <td>112..127</td> <td>128..143</td> <td>144..159</td> <td>160..175</td> <td>176..191</td> <td>192..207</td> <td>208..223</td> <td>224..239</td> <td>240..254</td> </tr> </table>	fix	blackout	1fps	2fps	3fps	4fps	5fps	6fps	7fps	8fps	9fps	10fps	12fps	14fps	16fps	fix	0 ... 15	16 ... 31	32 ... 47	48 ... 63	64 ... 79	80 ... 95	96 ... 111	112..127	128..143	144..159	160..175	176..191	192..207	208..223	224..239	240..254
fix	blackout	1fps	2fps	3fps	4fps	5fps	6fps	7fps	8fps	9fps	10fps	12fps	14fps	16fps	fix																			
0 ... 15	16 ... 31	32 ... 47	48 ... 63	64 ... 79	80 ... 95	96 ... 111	112..127	128..143	144..159	160..175	176..191	192..207	208..223	224..239	240..254																			

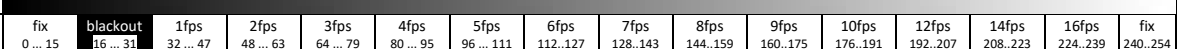
Ch.	Function	Map. Mappa: Master+RGBW+Strobe RGBW→RGB																																
1	Master Dimmer																																	
2	R																																	
3	G																																	
4	B																																	
5	W																																	
6	Strobo rate	<table border="1"> <tr> <td>fix</td> <td>blackout</td> <td>1fps</td> <td>2fps</td> <td>3fps</td> <td>4fps</td> <td>5fps</td> <td>6fps</td> <td>7fps</td> <td>8fps</td> <td>9fps</td> <td>10fps</td> <td>12fps</td> <td>14fps</td> <td>16fps</td> <td>fix</td> </tr> <tr> <td>0 ... 15</td> <td>16 ... 31</td> <td>32 ... 47</td> <td>48 ... 63</td> <td>64 ... 79</td> <td>80 ... 95</td> <td>96 ... 111</td> <td>112..127</td> <td>128..143</td> <td>144..159</td> <td>160..175</td> <td>176..191</td> <td>192..207</td> <td>208..223</td> <td>224..239</td> <td>240..254</td> </tr> </table>	fix	blackout	1fps	2fps	3fps	4fps	5fps	6fps	7fps	8fps	9fps	10fps	12fps	14fps	16fps	fix	0 ... 15	16 ... 31	32 ... 47	48 ... 63	64 ... 79	80 ... 95	96 ... 111	112..127	128..143	144..159	160..175	176..191	192..207	208..223	224..239	240..254
fix	blackout	1fps	2fps	3fps	4fps	5fps	6fps	7fps	8fps	9fps	10fps	12fps	14fps	16fps	fix																			
0 ... 15	16 ... 31	32 ... 47	48 ... 63	64 ... 79	80 ... 95	96 ... 111	112..127	128..143	144..159	160..175	176..191	192..207	208..223	224..239	240..254																			

- RDM COMMANDS**

Standard commands		Special commands	
DISC_UNIQUE_BRANCH	✓	PRODUCT_DETAIL_ID_LIST	✓
DISC_MUTE	✓	DEVICE_MODEL_DESCRIPTION	✓
DISC_UN_MUTE	✓	MANUFACTURER_LABEL	✓
SUPPORTED_PARAMETERS	✓	DEVICE_LABEL	✓
PARAMETER_DESCRIPTION	✓	BOOT_SOFTWARE_VERSION_ID	✓
DEVICE_INFO	✓	BOOT_SOFTWARE_VERSION_LABEL	✓
SOFTWARE_VERSION_LABEL	✓	DMX_PERSONALITY	✓
DMX_START_ADDRESS	✓	DMX_PERSONALITY_DESCRIPTION	✓
IDENTIFY_DEVICE	✓	SLOT_INFO	✓
		SLOT_DESCRIPTION	✓
		DEFAULT_SLOT_VALUE	✓

- DMX Master/Slave**

Example to the Master/Slave connection

More devices can be connected following a master/slave configuration. Master and Slave must be the same DIP-SWITCH configuration. To select the desired local command, DIP-SWITCH need to be set as explained in Setup DMX MASTER/SLAVE on page 16 and 17.

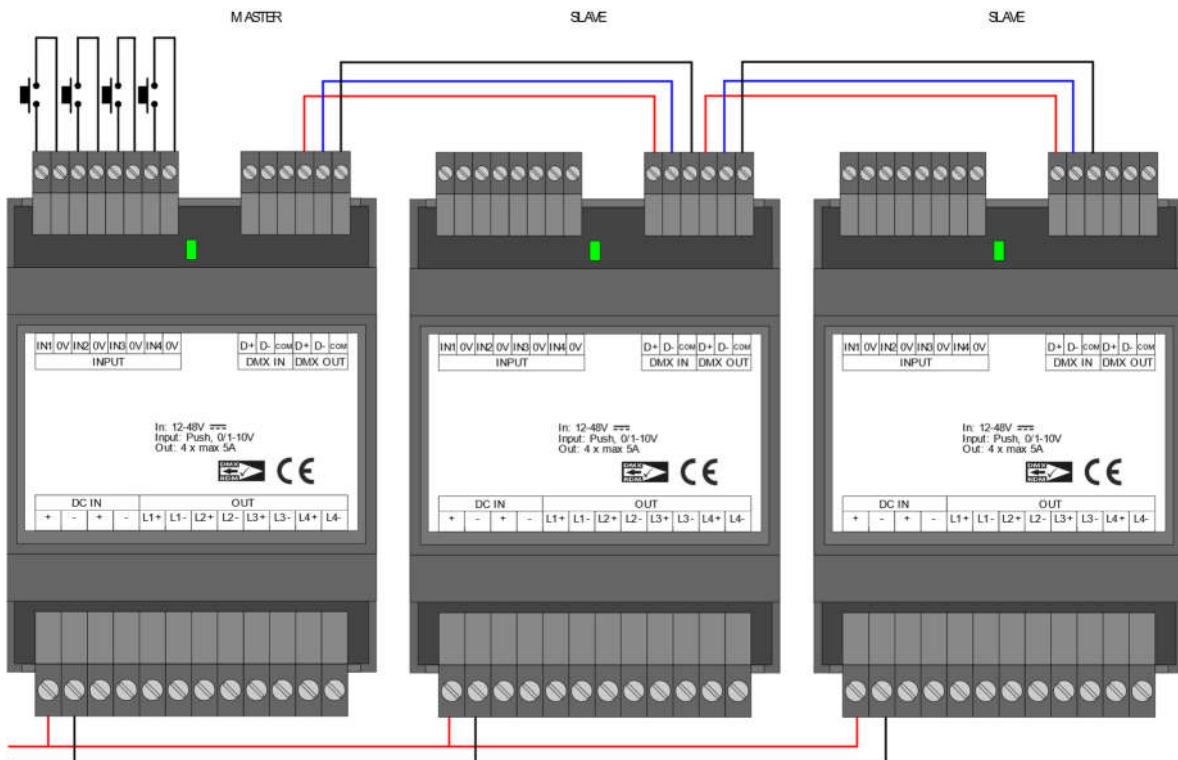

- **SETUP DMX Master/Slave**



Master:

Note: master and slave must have setted the same map (switches from 4 to 6)

Default Master:

F00			MASTER
-----	---	--	--------

Master with FADE UP / FADE DOWN:

From F00		to FFF		<p>MASTER with fade:</p> <p>Selector “x 10” = UP fade time Selector “x 1” = DOWN fade time 0 = no fade, F=60seconds (see table)</p>
-------------	---	-----------	--	--

Fade Times:

1	2	3	4	5	6	7	8	9	A	B	C	D	E	F
NO fade	0.5s	1s	2s	3s	4s	5s	6s	7s	8s	9s	10s	15s	20s	30s

Examples:

Turn on/off without fade (no fade UP/DOWN): F00

Turn on without fade (no fade UP) and turn off fade of 5 seconds (fade DOWN): F06

Turn on fade of 1 seconds (fade UP) and turn off fade of 10 seconds (fade DOWN): F2B

Notes:

This function is available on maps: “Dimmer”, “Dim to Warm”, “Tunable White”, “Smart Colours”

The Slaves follow master fade ramps.

Slave:

Default Slave:



E00			SLAVE
-----	---	--	-------



Colour Wave effect (only in map “Smart HSV”):

Easy creates a “Colour Wave” effect, adding a delay form, the master phase synchronism.





The delay is selected on each slave in step of 15°, form 0° (E00) to 345° (E23).

From E00		to E23		<p>SLAVE, Colour Wave effect: 00 = sync with master (no wave) 01 = 15° phase ... 08 = 120° phase ... 16 = 240° phase ... 23 = 345° phase</p>
-----------------	---	---------------	--	---

Phase delay:

E00	E01	E02	E03	E04	E05	E06	E07	E08	E09	E10	E11	E12	E13	E14	E15	E16	E17	E18	E19	E20	E21	E22	E23
0°	15°	30°	45°	60°	75°	90°	105°	120°	135°	150°	165°	180°	195°	210°	225°	240°	255°	270°	285°	300°	315°	330°	345°

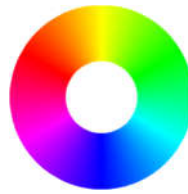
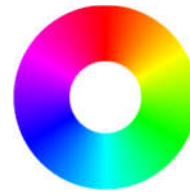
Examples:

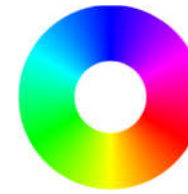
					
E00 0° Sync with master	E04 60° phase delay	E08 120° phase delay R→B, G→R, B→G	E12 180° phase delay Complementary colour	E16 240° phase delay R→G, G→B, B→R	E20 300° phase delay

- Control4 Integration**

See the SGDD-C4-3 Device Manual or send a request to info@adeogroup.it