

UNITS mm [in]		MODEL VAC-S18U	
DRAWN Shibata 2021/04/05	CHECKED Watanabe 2021/04/05	APPROVED Kadowaki 2021/04/05	PART NAME 外観図 DWG No. 114E81
IDK Corporation www.idk.co.jp			REVISION A1
SCALE : 1:2 (A3)			PAGE 1 / 2

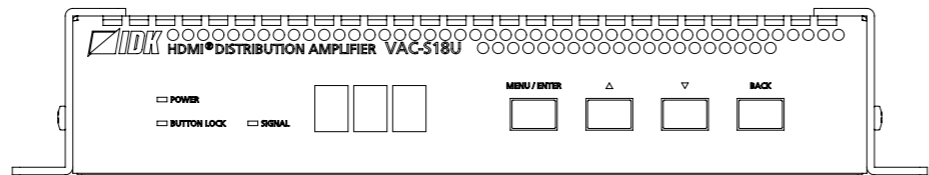
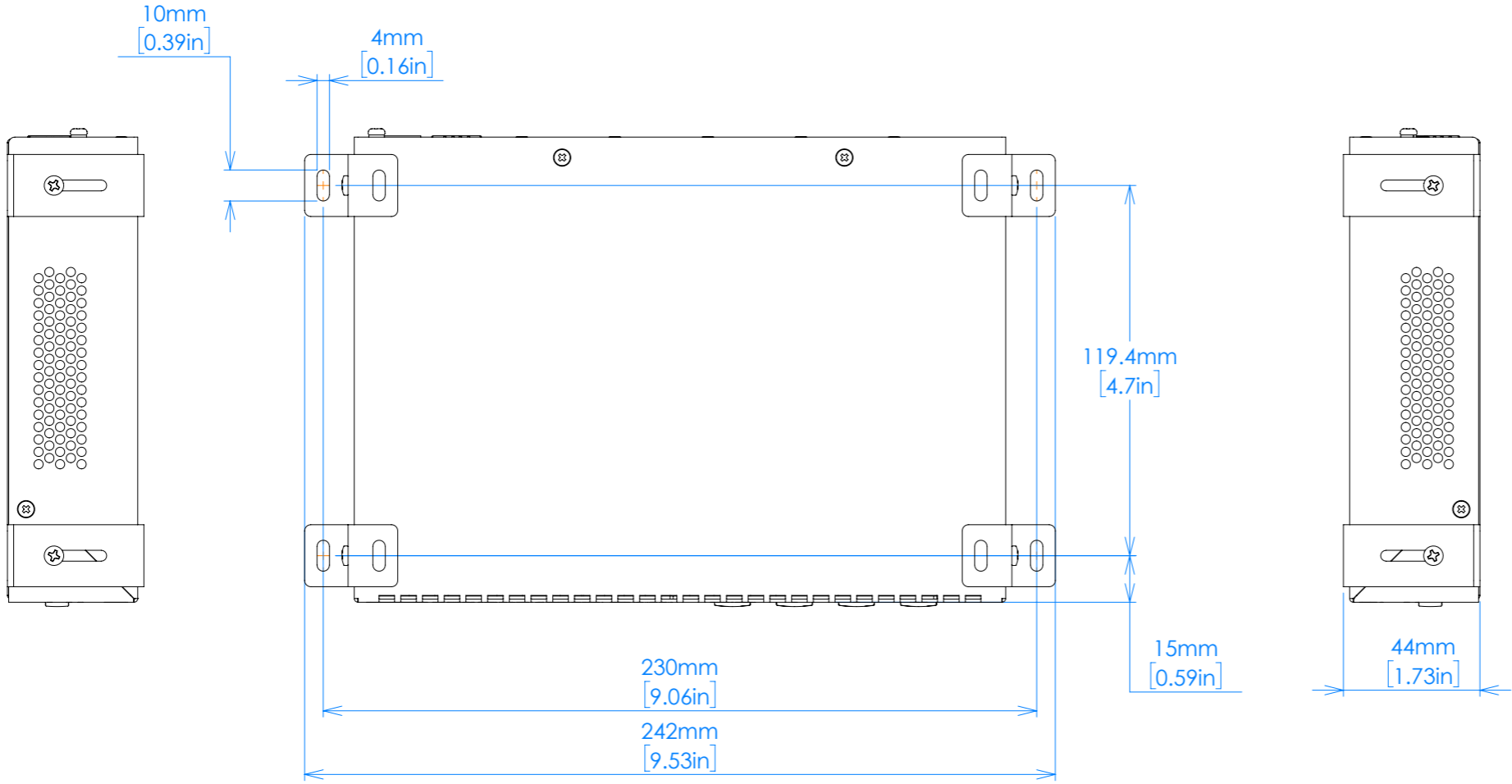
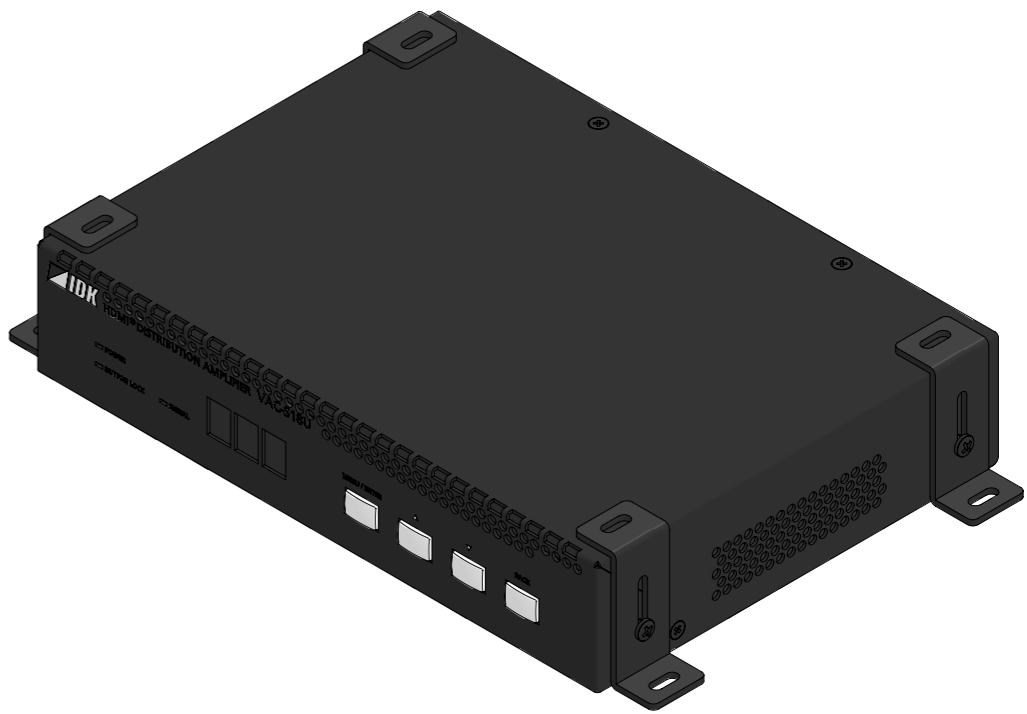
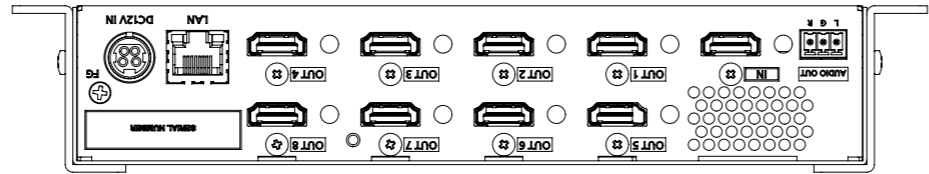
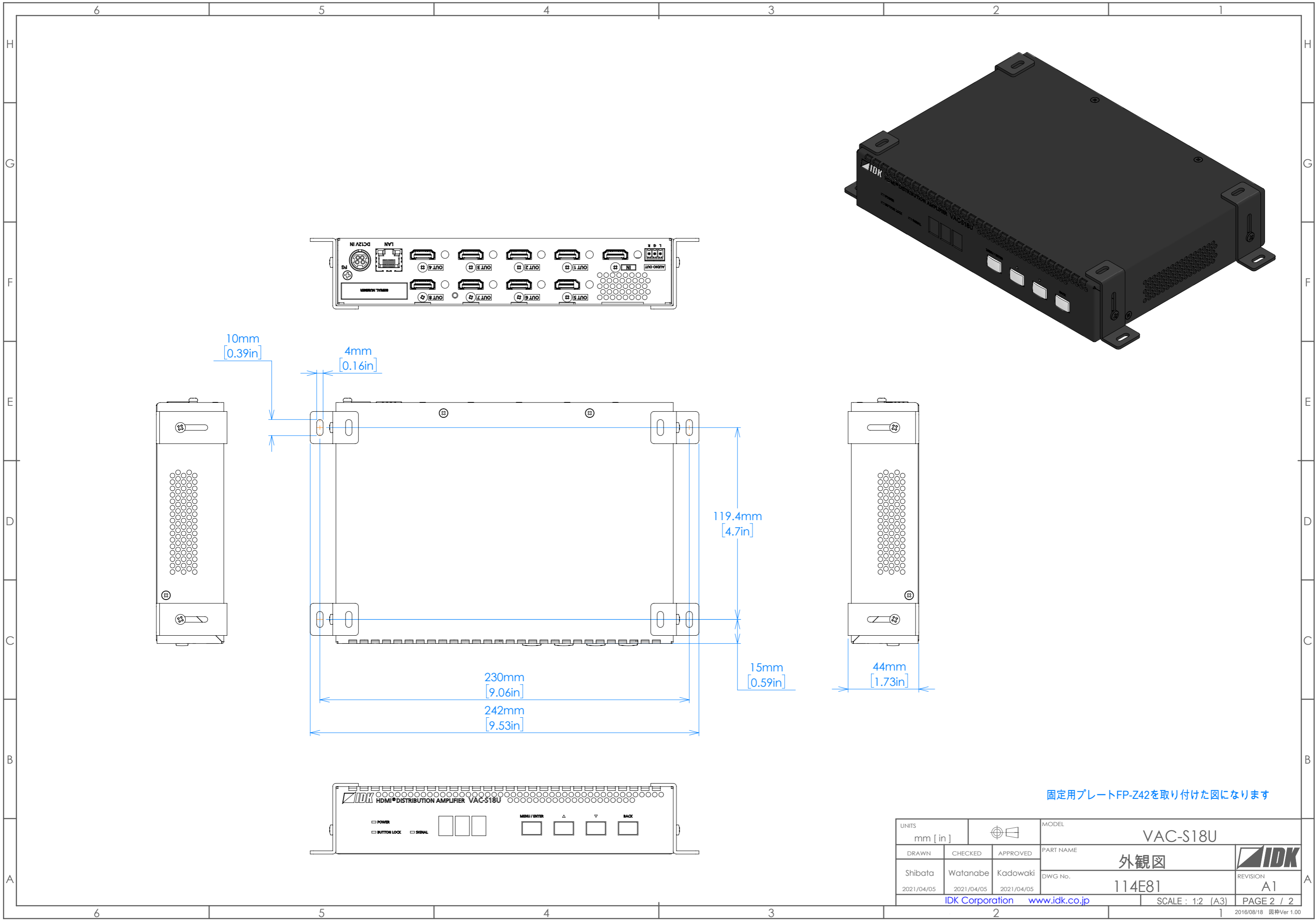

固定用プレートFP-Z42を取り付けた図になります

UNITS mm [in]		MODEL VAC-S18U	
DRAWN Shibata 2021/04/05	CHECKED Watanabe 2021/04/05	APPROVED Kadowaki 2021/04/05	PART NAME 外観図 DWG No. 114E81
IDK Corporation www.idk.co.jp			REVISION A1
SCALE : 1:2 (A3)			PAGE 2 / 2