

4K@60 and HDCP 2.2 supported PoH Injector

# HDC-P1502

---

<User Guide>

Ver.1.1.1

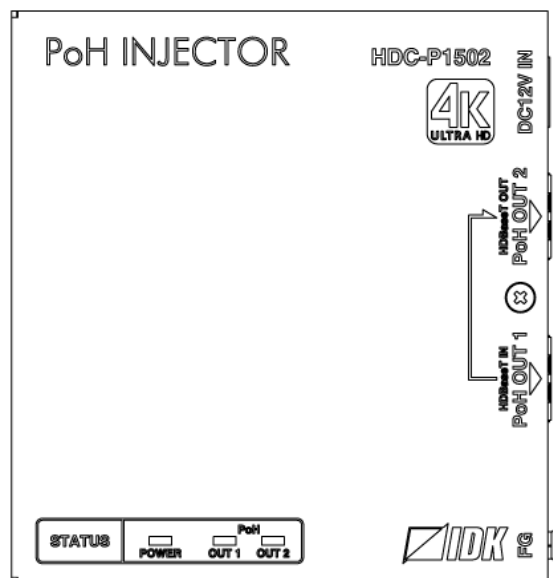

- Thank you for choosing our product.
- To ensure the best performance of this product, please read this user guide fully and carefully before using it and keep this manual together with the product for future reference as needed.

## **Trademarks**

- Blu-ray Disc and Blu-ray are trademarks of Blu-ray Disc Association.
- ETHERNET is a registered trademark of Fuji Xerox Co., Ltd.
- HDBaseT™ and the HDBaseT Alliance Logo are trademarks of the HDBaseT Alliance.
- All other company and product names mentioned in this manual are either registered trademarks or trademarks of their respective owners. In this manual, the “®” or “™” marks may not be specified.

# Before reading this manual

- All rights reserved.
- Some information contained in this User guide such as exact product appearance, diagrams, menu operations, and so on may differ depending on the product version.
- This User guide is subject to change without notice. You can download the latest version from IDK's website at: [www.idkav.com](http://www.idkav.com)

## FCC STATEMENT

This equipment has been tested and found to comply with the limits for a Class A digital device, pursuant to part 15 of the FCC Rules. These limits are designed to provide reasonable protection against harmful interference when the equipment is operated in a commercial environment. This equipment generates, uses, and can radiate radio frequency energy and, if not installed and used in accordance with the instruction manual, may cause harmful interference to radio communications. Operation of this equipment in a residential area is likely to cause harmful interference, in which case the user will be required to correct the interference at his own expense.

## CE MARKING

This equipment complies with the essential requirements of the relevant European health, safety and environmental protection legislation.

## WEEE MARKING











Waste Electrical and Electronic Equipment (WEEE), Directive 2002/96/EC  
(This directive is only valid in the EU.)

This equipment complies with the WEEE Directive (2002/96/EC) marking requirement.  
The left marking indicates that you must not discard this electrical/electronic equipment in domestic household waste.

# Safety Instructions

Read and understand all safety and operating instructions before using this product. Follow all instructions and heed all warnings/cautions.

Enforcement Symbol	Description
 <b>Warning</b>	Indicates the presence of a hazard that may result in death or serious personal injury if the warning is ignored or the product is handled incorrectly.
 <b>Caution</b>	Indicates the presence of a hazard that may cause minor personal injury or property damage if the caution is ignored or the product is handled incorrectly.



Symbol	Description	Example
 Caution	This symbol is intended to alert the user. (Warning and caution)	 Hot surfaces Caution
 Prohibited	This symbol is intended to prohibit the user from specified actions.	 Do not disassemble
 Instruction	This symbol is intended to instruct the user.	 Unplug

# Warning





## ■ For lifting heavy products:

 <b>Instruction</b>	<ul style="list-style-type: none"> <li>● <b>Lifting must be done by two or more personnel.</b></li> </ul> <p>To avoid injury: When lifting the product, bend your knees, keep your back straight and get close to it with two or more persons.</p>
---	--

## ■ For installing and connecting products:

 <b>Prohibited</b>	<ul style="list-style-type: none"> <li>● <b>Do not place the product upon a surface that may give way or that may become unstable.</b></li> </ul> <p>Install the product in a secure and stable place to prevent it from falling and possibly causing injury.</p> <ul style="list-style-type: none"> <li>● <b>Secure the product if installing in locations prone to vibration or movement.</b></li> </ul> <p>Otherwise, it may move unexpectedly or it may fall and lead to injury.</p>
 <b>Instruction</b>	<ul style="list-style-type: none"> <li>● <b>Installation work must be performed by professionals.</b></li> </ul> <p>The product is intended to be installed by skilled technicians. For installation, please contact a system integrator or IDK. Improper installation may lead to the risk of fire, electric shock, injury, or property damage.</p> <ul style="list-style-type: none"> <li>● <b>Insert the power plug into an outlet that is unobstructed.</b></li> </ul> <p>Unobstructed access to the plug enables unplugging the product in case of any extraordinary failure, abnormal situation or for easy disconnection during extended periods of non-use.</p> <ul style="list-style-type: none"> <li>● <b>Insert the power plug into an appropriate outlet completely.</b></li> </ul> <p>If the plug is partially inserted, arcing may cause the connection to overheat, increasing the risk of electrical shock or fire. Do not use a damaged plug or connect to a damaged outlet.</p> <ul style="list-style-type: none"> <li>● <b>Unplug the product from the AC power source during installation or service.</b></li> </ul> <p>When connecting peripheral devices to this product, unplug all involved devices from outlets. Ground potential differences may cause fire or other difficulties.</p>

## ■ For operating products:

 <b>Prohibited</b>	<ul style="list-style-type: none"> <li>● <b>Keep out any foreign objects.</b></li> </ul> <p>To avoid fire or electric shock, do not permit foreign objects, such as metal and paper, to enter the product from vent holes or other apertures.</p> <ul style="list-style-type: none"> <li>● <b>For power cable/plug:</b></li> </ul> <ul style="list-style-type: none"> <li>▪ Do not scratch, heat, or modify, including splicing or lengthening them.</li> <li>▪ Do not pull, place heavy objects on them, or pinch them.</li> <li>▪ Do not bend, twist, tie or clamp them together forcefully.</li> </ul> <p>Misuse of the power cable and plug may cause fire or electric shock. If power cables/plugs become damaged, contact your IDK representative.</p>
 <b>Do not disassemble</b>	<ul style="list-style-type: none"> <li>● <b>Do not repair, modify or disassemble.</b></li> </ul> <p>Since the product includes circuitry that uses potentially lethal, high voltage levels, disassembly by unauthorized personnel may lead to the risk of fire or electric shock. For internal inspection or repair, contact your IDK representative.</p>
 <b>Do not touch</b>	<ul style="list-style-type: none"> <li>● <b>Do not touch the product and connected cables during electrical storms.</b></li> </ul> <p>Contact may cause electric shock.</p>
 <b>Instruction</b>	<ul style="list-style-type: none"> <li>● <b>Clean the power plug regularly.</b></li> </ul> <p>If the plug is covered in dust, it may increase the risk of fire.</p> <ul style="list-style-type: none"> <li>● <b>The product must be earthed.</b></li> </ul> <p>To reduce the risk of electrical shock, ensure the product is connected to a mains socket outlet with a protective earthing connection.</p>



■ **If the following problem occurs:**

 <b>Unplug</b>	<ul style="list-style-type: none"> <li>● <b>Unplug immediately if the product smokes, makes unusual noise, or produces a burning odor.</b> If you continue to use the product under these conditions, it may cause electric shock or fire.</li> <li>● <b>Unplug immediately if the product is damaged by falling or having been dropped.</b> If you continue to use the product under these conditions, it may increase the risk of electrical shock or fire. For maintenance and repair, contact your IDK representative.</li> <li>● <b>Unplug immediately if water or other objects are directed inside.</b> If you continue to use the product under these conditions, it may increase the risk of electrical shock or fire. For maintenance and repair, contact your IDK representative.</li> </ul>
--	---







## Caution

■ **For installing and connecting products:**

 <b>Prohibited</b>	<ul style="list-style-type: none"> <li>● <b>Do not place the product in a location where it will be subjected to high temperatures.</b> If the product is subjected to direct sunlight or high temperatures while under operation, it may affect the product's performance and reliability and may increase the risk of fire.</li> <li>● <b>Do not store or operate the product in dusty, oil smoke filled, or humid place.</b> If the product is placed near humidifiers or in a dusty area, it may increase the risk of fire or electric shock.</li> <li>● <b>Do not block the vent holes.</b> If ventilation slots are blocked, it may cause the product to overheat, affecting performance and reliability and may increase the risk of fire.</li> <li>● <b>Do not place or stack heavy items on the product.</b> Failure to observe this precaution may result in damage to the product and other property and may lead to the risk of personal injury.</li> <li>● <b>Do not exceed ratings of outlet and wiring devices.</b> Exceeding the rating of an outlet may increase the risk of fire and electric shock.</li> </ul>
 <b>No wet hands</b>	<ul style="list-style-type: none"> <li>● <b>Do not handle power plug with wet hands.</b> Failure to observe this precaution may increase the risk of electrical shock.</li> </ul>
 <b>Instruction</b>	<ul style="list-style-type: none"> <li>● <b>Use and store the product within the specified temperature/humidity range.</b> If the product is used outside the specified range for temperature and humidity continuously, it may increase the risk of fire or electric shock.</li> <li>● <b>Do not place the product at elevations of 1.24 mi. (2,000 m) or higher above sea level.</b> Failure to do so may shorten the life of the internal parts and result in malfunctions.</li> <li>● <b>When mounting the product into the rack, provide sufficient cooling space.</b> Mount the product in a rack meeting EIA standards, and maintain spaces above and below for air circulation. For your safety as required, attach an L-shaped bracket in addition to the panel mount bracket kit to improve mechanical stability.</li> <li>● <b>Never insert screws without the rubber feet into the threaded holes on the bottom of the product.</b> Never insert screws without the rubber feet into the threaded holes on the bottom of the product. Doing so may lead to damage when the screws contact electrical circuitry or components inside the product. Reinstall the originally supplied rubber feet using only the originally supplied screws.</li> </ul>

■ **For operating products:**

 <p><b>Hot surfaces Caution</b></p>	<p><b>For products with the hot surfaces caution label only:</b></p> <ul style="list-style-type: none"> <li>● <b>Do not touch the product's hot surface.</b></li> </ul> <p>If the product is installed without enough space, it may cause failures of other products operation. If you touch product's hot surface, it may cause burn.</p>
 <p><b>Prohibited</b></p>	<ul style="list-style-type: none"> <li>● <b>Use only the supplied power cable and AC adapter.</b></li> <li>● <b>Do not use the supplied power cable and AC adapter with other products.</b></li> </ul> <p>If non-compliant adapter or power cables are used, it may increase the risk of fire or electrical shock.</p>
 <p><b>Unplug</b></p>	<ul style="list-style-type: none"> <li>● <b>If the product won't be used for an extended period of time, unplug it.</b></li> </ul> <p>Failure to observe this precaution may increase the risk of fire.</p> <ul style="list-style-type: none"> <li>● <b>Unplug the product before cleaning.</b></li> </ul> <p>To prevent electric shock.</p>
 <p><b>Instruction</b></p>	<ul style="list-style-type: none"> <li>● <b>If cooling fan stops, power off the product and contact us.</b></li> </ul> <p>Failure to do so may rise internal temperature and increase the risk of malfunction, fire, or electric shock.</p> <ul style="list-style-type: none"> <li>● <b>Keep vents clear of dust.</b></li> </ul> <p>If the vent holes near the cooling fan or near the fan are covered with dust, internal temperature rises and it may increase the risk of malfunction. Clean the vent holes and near the fan as needed.</p> <p>If dust accumulates inside of the product, it may increase the risk of malfunction, fire, or electric shock. Periodic internal cleaning, especially before humid rainy season, is recommended. For internal cleaning, contact your IDK representative.</p>

## Table of Contents

---

1	Included Items.....	9
2	Product outline .....	10
3	Features.....	11
4	Panels .....	12
5	System configuration example.....	13
6	Precautions .....	14
6.1	Installation.....	14
6.1.1	Cable.....	14
6.1.2	Twisted pair cable for extension .....	15
6.1.3	DIN plug AC adapter with lock .....	16
7	Product specification.....	18
8	Troubleshooting .....	19



# 1 Included Items

---

Ensure all items below are included in the package.

If any items are missing or damaged, please contact IDK.

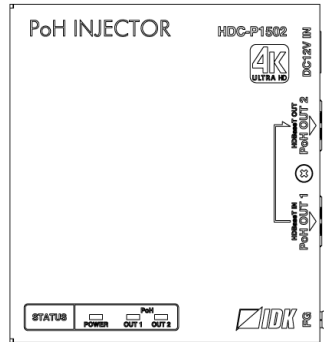

One (1) main unit HDC-P1502

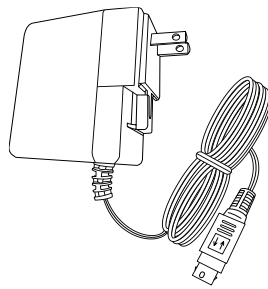

One (1) DIN plug AC adapter with locking mechanism (4 ft. (1.2 m))

**[Fig. 1.1] Included items**

## 2 Product outline

The HDC-P1502 (hereafter referred to as “HDC”) is a single port power injector that supplies power to a PoH transmitter and receiver, such as HDC-TH100WP (Wall-plate HDBaseT transmitter). Since the injector provides power to a transmitter and receiver (up to 15 W per device) simultaneously by installing within the HDBaseT transmission line, it eliminates the need for a local power supply. The HDC-P1502 stops supplying power if detecting PoH in compliant, twisted pair cable’s short, overload, and heat problem. Video up to 1080p (24 bit) or 148 MHz dot clock video can be transmitted up to 492 ft. (150 m) by connecting IDK’s HDBaseT products supporting long reach mode and 328 ft. (100 m).

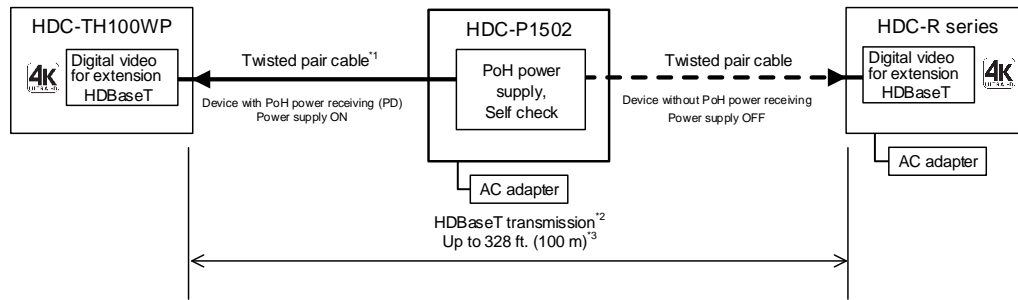

<sup>1</sup> For twisted pair cable for supplying power, cables thicker than AWG 24 are recommended.

<sup>2</sup> For Transmission distance longer than 164 ft. (50 m), Cat5e STP, Cat6 UTP / STP, and CAT.5E HDC cables are recommended.

For 4K format longer than 230 ft. (70 m), Cat5e STP / Cat6 STP / CAT.5E HDC cables are recommended.

For Long reach model longer than 328 ft. (100 m), Cat5e STP / Cat6 STP / CAT.5E HDC cables are recommended.

<sup>3</sup> Maximum extension distance

Up to 492 ft. (150 m) : 1080p (24 bit) in Long reach mode. For Long reach mode, use IDK’s twisted pair cable transmitter or receiver that supports 328 ft. (100 m) or longer. The maximum value was obtained when 1080p (24 bit) video signal is transmitted over Cat5e STP, Cat6 STP, or CAT.5E HDC cable in Long reach mode.

[Fig. 2.1] Application example

### Tips:

- HDC-TH100WP (Wall-plate HDBaseT transmitter with PoH power supplied can be connected.
- For setting of long reach mode, refer to the user guide of IDK’s HDBaseT transmitter or receiver which supported to long reach mode with maximum extension distance of 100 m or longer.

### Note:

Twisted pair that is thicker than AWG 24 is recommended for supplying power.

## 3 Features

---

### ■ Video

- Up to 4K@60
- HDCP 1.4 / 2.2 (Pass through)
- Up to 328 ft. (100 m) (4K@60) over Cat5e STP / Cat6 STP / CAT.5E HDC cable
- Cat5e UTP can be used<sup>\*1</sup>
- Up to 328 ft. (100 m) over Cat6 UTP cable<sup>\*2</sup>
- Up to 492 ft. (150 m) (1080p (24 bits) or less) with device supporting Long Reach Mode<sup>\*3</sup>

### ■ Others

- PoH power supply (equivalent to IEEE802.3af)
- Self check
- Power supply to transmitter and receiver simultaneously
- Power supply even with Long Reach Mode
- AC adapter with locking mechanism
- Up to 4 units can be mounted into 1U rack mount

<sup>\*1</sup> For transmission distance longer than 164 ft. (50 m), Cat5e STP, Cat6 UTP / STP, and CAT.5E HDC cables are recommended.

<sup>\*2</sup> For 4K format longer than 230 ft. (70 m), Cat5e STP / Cat6 STP / CAT.5E HDC cables are recommended.

<sup>\*3</sup> Maximum extension distance

Up to 492 ft. (150 m): 1080p (24 bit) in Long reach mode. For Long reach mode, use IDK's HDBaseT transmitter or receiver that supports 328 ft. (100 m) or longer.

The maximum value was obtained when 1080p (24 bit) video signal is transmitted over Cat5e STP, Cat6 STP, or CAT.5E HDC cable in Long reach mode.

## 4 Panels

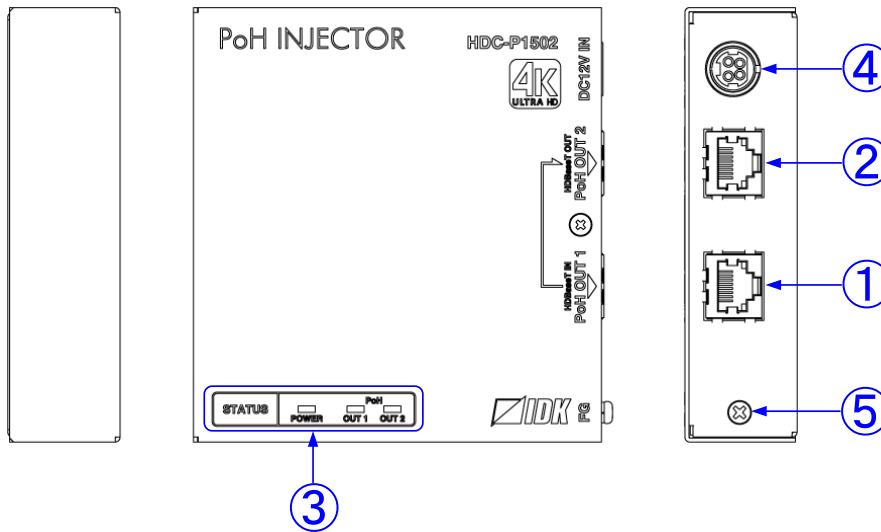

[Fig. 4.1] HDC-P1502 drawing

[Table 4.1] Name and description

#	Name	Description
①	HDBaseT input connector (HDBaseT IN / PoH OUT1)	Input connector for HDBaseT signal. Connects to HDBaseT transmitter. If the connected transmitter supports PoH, power can be supplied up to 15 W per device.
②	HDBaseT output connector (HDBaseT OUT / PoH OUT2)	Output connector for HDBaseT signal. Connects to HDBaseT receiver. If the connected receiver supports PoH, power can be supplied up to 15 W per device.
③	LED lights	<ul style="list-style-type: none"> <li>• POWER (Green) Shows the power supply status from the AC adapter to the HDC. Illuminates in green : Powered Does not illuminate : Not powered</li> <li>• OUT1 (Yellow) Illuminates in yellow : Power is supplied to HDBaseT transmitter. Does not illuminate : No power is supplied to HDBaseT transmitter or no HDBaseT transmitter is connected.</li> <li>• OUT2 (Yellow) Illuminates in yellow : Power is supplied to HDBaseT receiver. Does not illuminate : No power is supplied to HDBaseT receiver or no HDBaseT receiver is connected.</li> </ul>
④	AC adapter connector	Connector for the supplied AC adapter. <b>【See: 6.1.3 DIN plug AC adapter with lock】</b>
⑤	Frame ground	Use for bonding chassis to local ground. An M3 screw is used.

## 5 System configuration example

Example: An HDC-TH100WP (Wall-plate HDBaseT transmitter with PoH power supplied and MSD-402 are connected to the HDC.

The HDC supplies power to HDC-TH100WP. Video up to 1080p (24 bit) or 148 MHz dot clock video can be transmitted up to 492 ft. (150 m) by connecting IDK's HDBaseT products supporting long reach mode and 328 ft. (100 m).

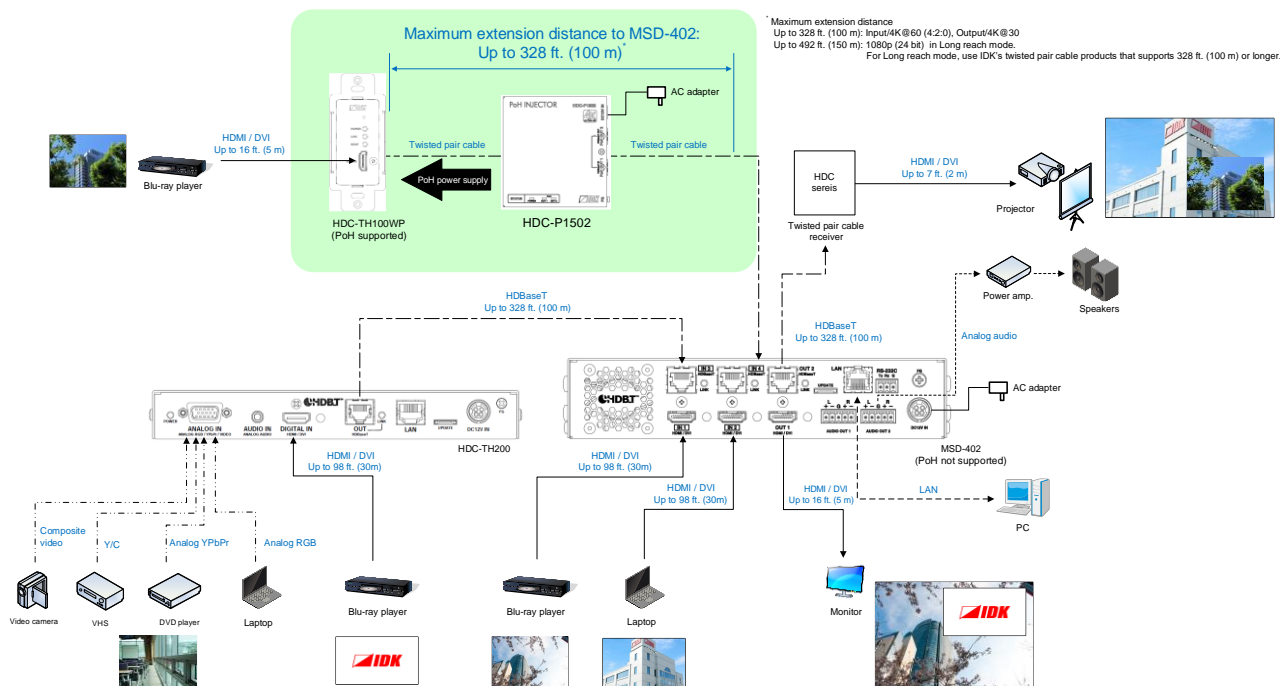

[Fig. 5.1] Application example (HDC-TH100WP and MSD-402 are connected)

**Tip:**

For setting of long reach mode, refer to the user guide of IDK's HDBaseT transmitter or receiver supporting 328 ft. (100 m) or longer long reach mode.

**Note:**

Twisted pair that is thicker than AWG 24 is recommended for supplying power.

## 6 Precautions

Before using HDC-P1502, follow the precautions and instructions below.

### 6.1 Installation

Follow the instructions below when installing HDC-P1502.

- Do not place the HDC-P1502 on another device directly.
- Do not block vent holes. To provide adequate ventilation, maintain sufficient clearances around the HDC-P1502 (1.2 in. (30 mm) or more).
- Do not install HDC-P1502 in a closed space.  
When placing them in an EIA rack-mount unit, prepare ventilating equipment to keep the ambient temperature at 40 degrees C/104 degrees F or less. If inadequately vented, the life of parts may be shortened and operation may be affected.  
(Exception: Installing to IDK's rack mounting RM-42HQ)
- When you do not use an EIA rack-mount unit, maintain adequate clearances (1.2 in. (30 mm) or more) as shown below.

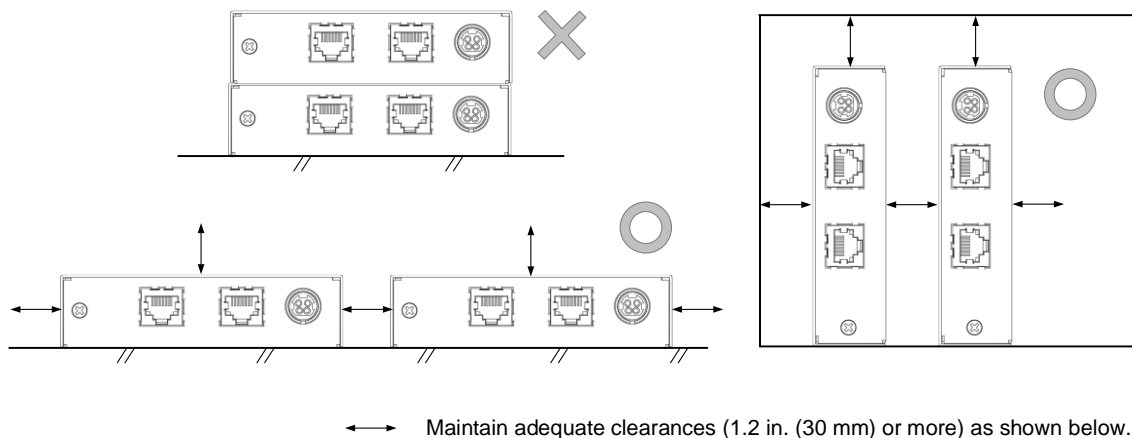

**[Fig. 6.1] Necessary clearances**

#### 6.1.1 Cable

Use the correct IDK's CAT.5E HDC cable\* or HDMI cable or HDMI-DVI conversion cable depending on the system configuration.

\* The CAT.5E HDC cable is a double-shielded twisted pair cable that optimizes video signal transmission. It is certified to 500 MHz bandwidth at distance up to 330 ft. (100 m) and verified to meet requirements specified by HDBaseT Alliance. The double-shielded structure protects video signal from outside interference.

## 6.1.2 Twisted pair cable for extension

To ensure the best performance of twisted pair cables, select a correct twisted pair cable and connect it correctly.

- Cat5e UTP/STP and Cat6 UTP/STP can be used, but we recommend CAT.5E HDC cable for optimal performance.
- If using an STP cable, connect the FG connector to a ground source. Otherwise, the shielding feature does not work correctly. When using a UTP cable, we still recommend using the ground connector.
- The shielded STP cables are less affected by interference or external noise than UTP cables.
- Connectors for long-haul extension are the same as that of eight-core modular connector used for Ethernet, but the transmission system is not the same so that it cannot be connected to Ethernet.
- The maximum extension distance of a twisted pair cable is shorter distance of the maximum extension distances of transmitter/receiver/sink device connected to the HDC.
- Pin assignments: T568A or T568B straight.
- Do not pull the cable hard. The allowable tension of the twisted pair cable is 110 N.
- Do not bend the connection cable at a sharp angle. Keep the bend radius four times of the cable diameter or larger.
- Do not tie the cable tightly; leave a space allowing the cable to move slightly.
- If you use multiple twisted pair cables, we recommended keeping a distance between the cables or not to place the cables closely in parallel.
- Keep the twisted pair cable as straight as you can. If you coil the cable, it is easily affected by noise.
- Do not place the cable in an electrically noisy environment, since high-speed signals are transmitted. Particularly when you use a high-output radio around the MSD, video or audio may be interrupted.
- If the total extension distance from the HDBaseT transmitter to receiver is 328 ft. (100 m) or less, up to two cable joints can be used. Products supporting Cat6A (10GBase-T) are recommended.
- For twisted pair cable used for PoH, thicker than AWG 24 cable is recommended.
- The table below shows supported extension distance for each twisted pair cable category. Note that the distance may shorten depending on the actual environment.

**[Table 6.1] Extension distance**

Noise influence	Category		Extension distance	TMDS clock	Recommended cable
Easily affected	UTP	Cat5e	50 m	$\leq 225$ MHz	For 164 ft. (50 m) or longer, CAT.5E HDC, Cat5e STP, Cat6 UTP / STP are recommended.
		Cat6	100 m		
				70 m	
Less affected	STP	Cat5e Cat6	100 m	Long reach mode $\leq 148$ MHz (1080p (24 bit) or less)	CAT.5E HDC, Cat5e STP, Cat6 STP
			150 m		

**Note:**

If there is a problem in the transmission path, video or audio may be interrupted. Check the precautions above. If the problem still cannot be solved, shortening the twisted pair cable may remedy the problem.

### 6.1.3 DIN plug AC adapter with lock

DIN plug AC adapter with locking mechanism differ from one country to another; use an appropriate AC plug. For inquiries for the AC plug, contact us directly.

#### ■ Attaching and removing AC plug

##### Removing:

Hold the joint of the AC adapter (①) and slide the AC plug from the AC adapter (②).

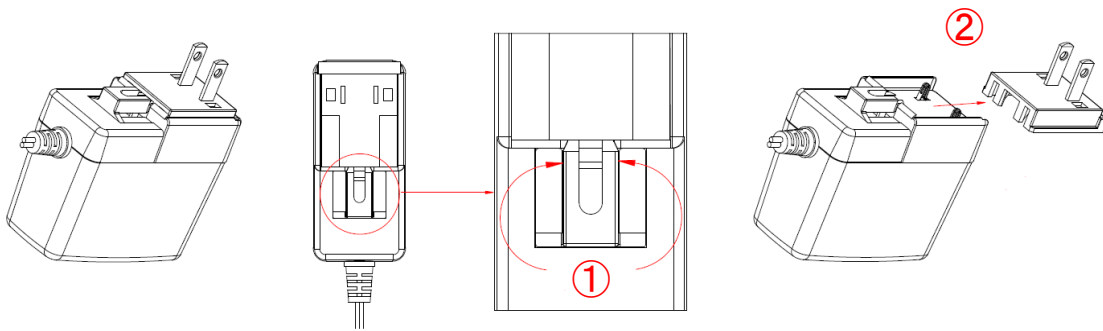

[Fig. 6.2] Removing AC plug (Example: Plug type A)

##### Attaching:

Attach the AC plug to the AC adapter (③) until it clicks (④).

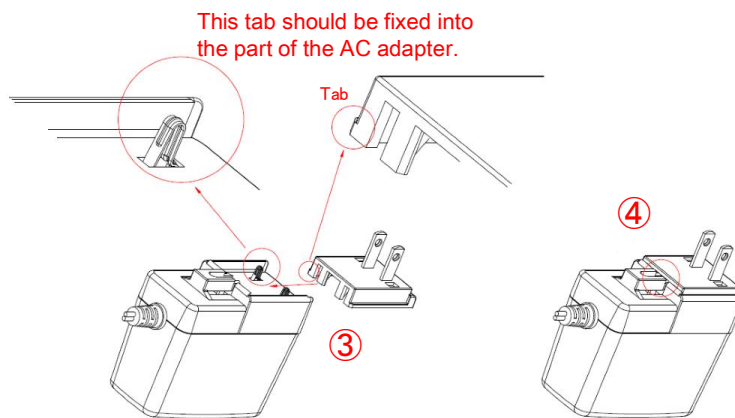

[Fig. 6.3] Attaching AC plug (Example: Plug type A)



**■ Plugging and unplugging DC plug**

Plug the DC plug to the power supply connector of the unit until it clicks.  
Hold the portion mentioned below when unplugging the DC plug.

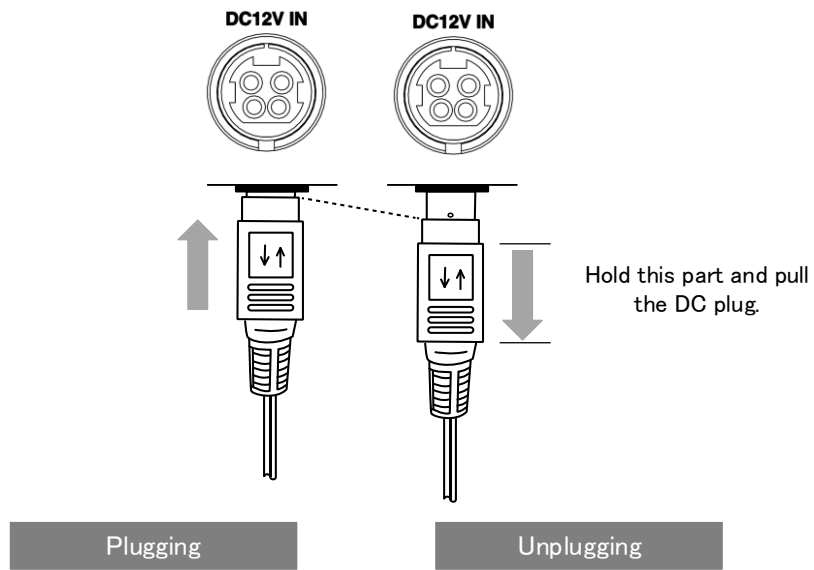

**[Fig. 6.4] Plugging and unplugging DC plug**

## 7 Product specification

Item	Description	
Input	1 input HDBaseT (*1) PoH power supply (PSE) (equivalent to IEEE802.3af) (*2) Connector: RJ-45	
Output	1 input HDBaseT (*1) PoH power supply (PSE) (equivalent to IEEE802.3af) (*2) Connector: RJ-45	
Cable (*3)	Cat5e UTP/STP, Cat6 UTP/STP, CAT.5E HDC cable	
Maximum extension distance	The distance may be 10% shorter than the shorter one of transmitter/receiver and transmitter/sink device.	
General	AC Adapter	Input: 100 - 240 VAC ±10%, 50 Hz/60 Hz ±3 Hz Output: DC 12 V 3 A 36.0 W (AC adapter is supplied)
	Power consumption	About 32 W
	Dimensions	4.2 (W) × 1.1 (H) × 3.9 (D)" (106 (W) × 27.5 (H) × 100 (D) mm) (EIA quarter rack wide) (Excluding connectors and the like)
	Weight	0.7 lbs. (0.3 kg)
	Temperature	Operating: 32°F to 104°F (0°C to +40°C) Storage: -4°F to +176°F (-20°C to +80°C)
	Humidity	Operating/Storage: 20% to 90% (Non Condensing)

\*1 The maximum resolution: 4K@60 (4:2:0), HDCP 1.4/2.2 (Pass through)

\*2 Please use a transmitter/receiver supporting PoH power receiving function (PD) (equivalent to IEEE 802.3af).

\*3 T568A or T568B straight wiring CAT.5E HDC cable is developed by IDK and meets requirements set by the HDBaseT alliance.  
Twisted pair that is thicker than AWG 24 is recommended for supplying power.

## 8 Troubleshooting

In case the HDC-P1502 does not work correctly, please check the following items first. Also refer to manuals for connected devices as well, since they may possibly be the cause of the problem.

- Are the HDC-P1502 and all devices plugged in and powered on normally?
- Are cables connected correctly?
- Are there no loose connections?
- Are correct cables for HDBaseT transmitter and receiver being used?
- Are signal specifications of connected devices matched to each other?
- Are settings of the sink device correct?
- Are there any nearby objects that may cause noise?

If additional assistance is required, please check the following items and then contact us.

No.	Checking items	Result
1	The same problem occurs at all connectors?	Yes or No
2	Operates correctly when connect devices using genuine cables without connecting of HDC-P1502?	Yes or No

---

## User Guide of HDC-P1502

Ver.1.1.1

Issued on: 16 August 2021

---



### Headquarters

IDK Corporation  
7-9-1 Chuo, Yamato-shi, Kanagawa-pref.  
242-0021 JAPAN  
TEL: +81-46-200-0764 FAX: +81-46-200-0765

Email: [idk\\_eng@idk.co.jp](mailto:idk_eng@idk.co.jp)

URL: [www.idkav.com](http://www.idkav.com)

### USA

IDK America Inc.  
72 Grays Bridge Road Suite 1-C, Brookfield, CT 06804  
TEL: +1-203-204-2445

Email: [sales@idkav.com](mailto:sales@idkav.com)

URL: [www.idkav.com](http://www.idkav.com)

### Europe

IDK Europe GmbH  
Lise-Meitner-Str. 6, D-40878 Ratingen  
TEL: +49-2102-578-301-0

Email: [info@idkav.eu](mailto:info@idkav.eu)

URL: [www.idkav.com](http://www.idkav.com)



### Product information Support

Arvanics Corporation  
7-9-1 Chuo, Yamato-shi, Kanagawa-pref.  
242-0021 JAPAN  
TEL: +81-46-259-6920 FAX: +81-46-259-6930

Email: [info@arvanics.com](mailto:info@arvanics.com)

URL: [www.arvanics.com](http://www.arvanics.com)

Information in this document is subject to change without notice.

©2018 IDK Corporation, all rights reserved. All trademarks mentioned are the property of their respective owners.