

4K@60/HDCP 2.2 Wall-plate HDBaseT Transmitter

HDC-TH100WPJ

<User Guide>

Ver.1.1.0

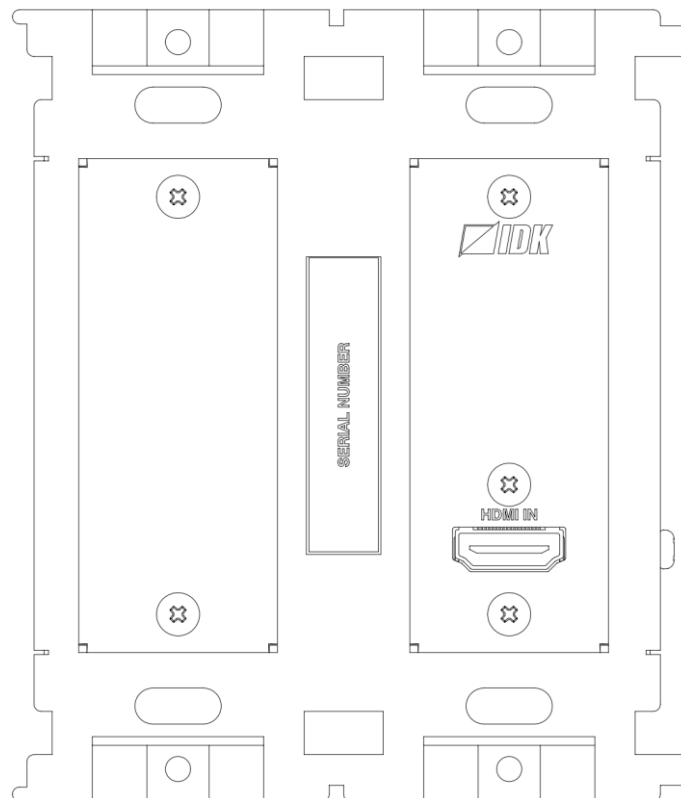

- Thank you for choosing our product.
- To ensure the best performance of this product, please read this user guide fully and carefully before using it and keep this manual together with the product for future reference as needed.

IDK Corporation

Trademarks

- Blu-ray Disc and Blu-ray are trademarks of Blu-ray Disc Association.
- ETHERNET is a registered trademark of Fuji Xerox Co., Ltd.
- HDBaseT™ and the HDBaseT Alliance Logo are trademarks of the HDBaseT Alliance.
- The terms HDMI and HDMI High-Definition Multimedia Interface, and the HDMI Logo are trademarks or registered trademarks of HDMI Licensing Administrator, Inc. in the United States and other countries.
- All other company and product names mentioned in this manual are either registered trademarks or trademarks of their respective owners. In this manual, the “®” or “™” marks may not be specified.

Before reading this manual

- All rights reserved.
- Some information contained in this User guide such as exact product appearance, diagrams, menu operations, and so on may differ depending on the product version.
- This User guide is subject to change without notice. You can download the latest version from IDK's website at: <http://www.idkav.com>
- Third-party products mentioned in this manual are for reference only and are not intended to force use.

FCC STATEMENT

This equipment has been tested and found to comply with the limits for a Class A digital device, pursuant to part 15 of the FCC Rules. These limits are designed to provide reasonable protection against harmful interference when the equipment is operated in a commercial environment. This equipment generates, uses, and can radiate radio frequency energy and, if not installed and used in accordance with the instruction manual, may cause harmful interference to radio communications. Operation of this equipment in a residential area is likely to cause harmful interference, in which case the user will be required to correct the interference at his own expense.

CE MARKING

This equipment complies with the essential requirements of the relevant European health, safety and environmental protection legislation.

WEEE MARKING











Waste Electrical and Electronic Equipment (WEEE), Directive 2002/96/EC
(This directive is only valid in the EU.)

This equipment complies with the WEEE Directive (2002/96/EC) marking requirement.
The left marking indicates that you must not discard this electrical/electronic equipment in domestic household waste.

Safety Instructions

Read and understand all safety and operating instructions before using this product. Follow all instructions and heed all warnings/cautions.

Enforcement Symbol	Description
 Warning	Indicates the presence of a hazard that may result in death or serious personal injury if the warning is ignored or the product is handled incorrectly.
 Caution	Indicates the presence of a hazard that may cause minor personal injury or property damage if the caution is ignored or the product is handled incorrectly.



Symbol	Description	Example
 Caution	This symbol is intended to alert the user. (Warning and caution)	 Hot surfaces Caution
 Prohibited	This symbol is intended to prohibit the user from specified actions.	 Do not disassemble
 Instruction	This symbol is intended to instruct the user.	 Unplug

Warning





■ For lifting heavy products:

 Instruction	<ul style="list-style-type: none"> ● Lifting must be done by two or more personnel. <p>To avoid injury: When lifting the product, bend your knees, keep your back straight and get close to it with two or more persons.</p>
---	--

■ For installing and connecting products:

 Prohibited	<ul style="list-style-type: none"> ● Do not place the product upon a surface that may give way or that may become unstable. <p>Install the product in a secure and stable place to prevent it from falling and possibly causing injury.</p> <ul style="list-style-type: none"> ● Secure the product if installing in locations prone to vibration or movement. <p>Otherwise, it may move unexpectedly or it may fall and lead to injury.</p>
 Instruction	<ul style="list-style-type: none"> ● Installation work must be performed by professionals. <p>The product is intended to be installed by skilled technicians. For installation, please contact a system integrator or IDK. Improper installation may lead to the risk of fire, electric shock, injury, or property damage.</p> <ul style="list-style-type: none"> ● Insert the power plug into an outlet that is unobstructed. <p>Unobstructed access to the plug enables unplugging the product in case of any extraordinary failure, abnormal situation or for easy disconnection during extended periods of non-use.</p> <ul style="list-style-type: none"> ● Insert the power plug into an appropriate outlet completely. <p>If the plug is partially inserted, arcing may cause the connection to overheat, increasing the risk of electrical shock or fire. Do not use a damaged plug or connect to a damaged outlet.</p> <ul style="list-style-type: none"> ● Unplug the product from the AC power source during installation or service. <p>When connecting peripheral devices to this product, unplug all involved devices from outlets. Ground potential differences may cause fire or other difficulties.</p>

■ For operating products:

 Prohibited	<ul style="list-style-type: none"> ● Keep out any foreign objects. <p>To avoid fire or electric shock, do not permit foreign objects, such as metal and paper, to enter the product from vent holes or other apertures.</p> <ul style="list-style-type: none"> ● For power cable/plug: <ul style="list-style-type: none"> ▪ Do not scratch, heat, or modify, including splicing or lengthening them. ▪ Do not pull, place heavy objects on them, or pinch them. ▪ Do not bend, twist, tie or clamp them together forcefully. <p>Misuse of the power cable and plug may cause fire or electric shock. If power cables/plugs become damaged, contact your IDK representative.</p>
 Do not disassemble	<ul style="list-style-type: none"> ● Do not repair, modify or disassemble. <p>Since the product includes circuitry that uses potentially lethal, high voltage levels, disassembly by unauthorized personnel may lead to the risk of fire or electric shock. For internal inspection or repair, contact your IDK representative.</p>
 Do not touch	<ul style="list-style-type: none"> ● Do not touch the product and connected cables during electrical storms. <p>Contact may cause electric shock.</p>
 Instruction	<ul style="list-style-type: none"> ● Clean the power plug regularly. <p>If the plug is covered in dust, it may increase the risk of fire.</p> <ul style="list-style-type: none"> ● The product must be earthed. <p>To reduce the risk of electrical shock, ensure the product is connected to a mains socket outlet with a protective earthing connection.</p>



■ **If the following problem occurs:**

 Unplug	<ul style="list-style-type: none"> ● Unplug immediately if the product smokes, makes unusual noise, or produces a burning odor. If you continue to use the product under these conditions, it may cause electric shock or fire. ● Unplug immediately if the product is damaged by falling or having been dropped. If you continue to use the product under these conditions, it may increase the risk of electrical shock or fire. For maintenance and repair, contact your IDK representative. ● Unplug immediately if water or other objects are directed inside. If you continue to use the product under these conditions, it may increase the risk of electrical shock or fire. For maintenance and repair, contact your IDK representative.
--	---



Caution

■ **For installing and connecting products:**

 Prohibited	<ul style="list-style-type: none"> ● Do not place the product in a location where it will be subjected to high temperatures. If the product is subjected to direct sunlight or high temperatures while under operation, it may affect the product's performance and reliability and may increase the risk of fire. ● Do not store or operate the product in dusty, oil smoke filled, or humid place. If the product is placed near humidifiers or in a dusty area, it may increase the risk of fire or electric shock. ● Do not block the vent holes. If ventilation slots are blocked, it may cause the product to overheat, affecting performance and reliability and may increase the risk of fire. ● Do not place or stack heavy items on the product. Failure to observe this precaution may result in damage to the product and other property and may lead to the risk of personal injury. ● Do not exceed ratings of outlet and wiring devices. Exceeding the rating of an outlet may increase the risk of fire and electric shock.
 No wet hands	<ul style="list-style-type: none"> ● Do not handle power plug with wet hands. Failure to observe this precaution may increase the risk of electrical shock.
 Instruction	<ul style="list-style-type: none"> ● Use and store the product within the specified temperature/humidity range. If the product is used outside the specified range for temperature and humidity continuously, it may increase the risk of fire or electric shock. ● Do not place the product at elevations of 1.24 mi. (2,000 m) or higher above sea level. Failure to do so may shorten the life of the internal parts and result in malfunctions. ● When mounting the product into the rack, provide sufficient cooling space. Mount the product in a rack meeting EIA standards, and maintain spaces above and below for air circulation. For your safety as required, attach an L-shaped bracket in addition to the panel mount bracket kit to improve mechanical stability. ● Never insert screws without the rubber feet into the threaded holes on the bottom of the product. Never insert screws without the rubber feet into the threaded holes on the bottom of the product. Doing so may lead to damage when the screws contact electrical circuitry or components inside the product. Reinstall the originally supplied rubber feet using only the originally supplied screws.

■ For operating products:





 <p>Hot surfaces Caution</p>	<p>For products with the hot surfaces caution label only:</p> <ul style="list-style-type: none"> ● Do not touch the product's hot surface. <p>If the product is installed without enough space, it may cause failures of other products operation. If you touch product's hot surface, it may cause burn.</p>
 <p>Prohibited</p>	<ul style="list-style-type: none"> ● Use only the supplied power cable and AC adapter. ● Do not use the supplied power cable and AC adapter with other products. <p>If non-compliant adapter or power cables are used, it may increase the risk of fire or electrical shock.</p>
 <p>Unplug</p>	<ul style="list-style-type: none"> ● If the product won't be used for an extended period of time, unplug it. <p>Failure to observe this precaution may increase the risk of fire.</p> <ul style="list-style-type: none"> ● Unplug the product before cleaning. <p>To prevent electric shock.</p>
 <p>Instruction</p>	<ul style="list-style-type: none"> ● If cooling fan stops, power off the product and contact us. <p>Failure to do so may rise internal temperature and increase the risk of malfunction, fire, or electric shock.</p> <ul style="list-style-type: none"> ● Keep vents clear of dust. <p>If the vent holes near the cooling fan or near the fan are covered with dust, internal temperature rises and it may increase the risk of malfunction. Clean the vent holes and near the fan as needed.</p> <p>If dust accumulates inside of the product, it may increase the risk of malfunction, fire, or electric shock. Periodic internal cleaning, especially before humid rainy season, is recommended. For internal cleaning, contact your IDK representative.</p>

Table of Contents

1	Included Items.....	9
2	Product outline	10
3	Features.....	10
4	Panels	11
5	System configuration example.....	13
6	Precautions	14
6.1	Power supply	14
6.2	Cable.....	16
6.2.1	Category cable for extension	16
6.2.2	Cabling	17
7	Installation	18
7.1	Switch box, bracket, and wallplate.....	19
7.2	Replacing HDC wallplate cover	20
8	Product specification.....	21
8.1	Dimensions	22
9	Troubleshooting	23

1 Included Items

Ensure all items below are included in the package.
 If any items are missing or damaged, please contact IDK.

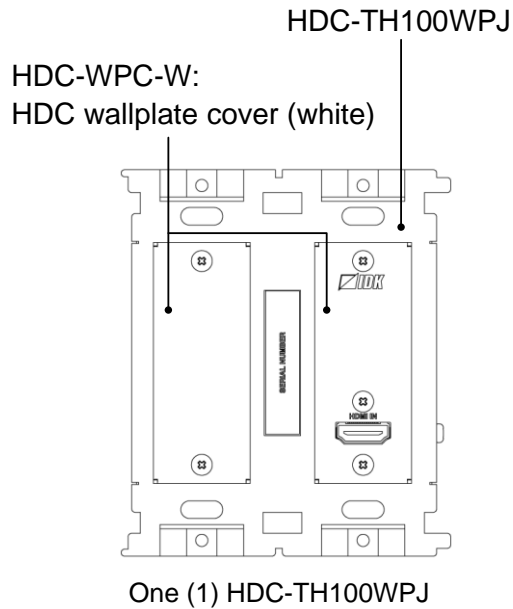

HDC wallplate cover (white) originally attached to HDC-TH100WPJ.

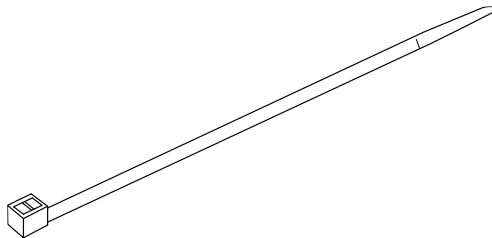

One (1) zip tie

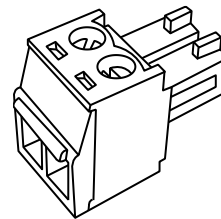

One (1) 2-pin terminal block

[Fig. 1.1] Included items

Tip:

For black wallplate cover (HDC-WPC-B), contact us as needed.

2 Product outline

The HDC-TH100WPJ (hereafter referred to as “HDC”) is a wall-mountable transmitter for a long-haul transmission of HDMI signal over one single category cable.

The image quality will not be deteriorated, since video signal is transmitted at a resolution up to 4K@60 without compression.

Input video signal is converted to HDBaseT signal and sent up to 328 ft. (100 m).

PoH (Power over HDBaseT) is supported. Connecting a receiver supporting PoH power supply (PSE) function eliminates the need for a local power supply.

3 Features

■ Video

- Up to 4K@60
- HDCP 1.4/2.2 (Pass-through)
- Up to 328 ft. (100 m) 4K@60 over CAT.5E HDC/Cat5e STP/Cat6 STP cable
- Transmission over Cat5e UTP cable*¹
- Up to 328 ft. (100 m) over Cat6 UTP cable*²
- Up to 492 ft. (150 m) in Long reach mode (1080p 60 Hz 24 bit or less)*³
- No actual extension delay (10 µs or less/328 ft. (100 m))

■ Others

- CEC (Pass-through)
- PoH (HDBaseT output)

*¹ If exceeding 164ft. (50 m), CAT.5E HDC, Cat5e STP, and Cat6 UTP/STP cables are recommended.

*² If the 4K format exceeds 230 ft. (70 m), CAT.5E HDC, Cat5e STP, and Cat6 STP cables are recommended.

*³ If exceeding 328 ft. (100 m) in Long reach mode, CAT.5E HDC, Cat5e STP, and Cat6 STP cables are recommended.

4 Panels

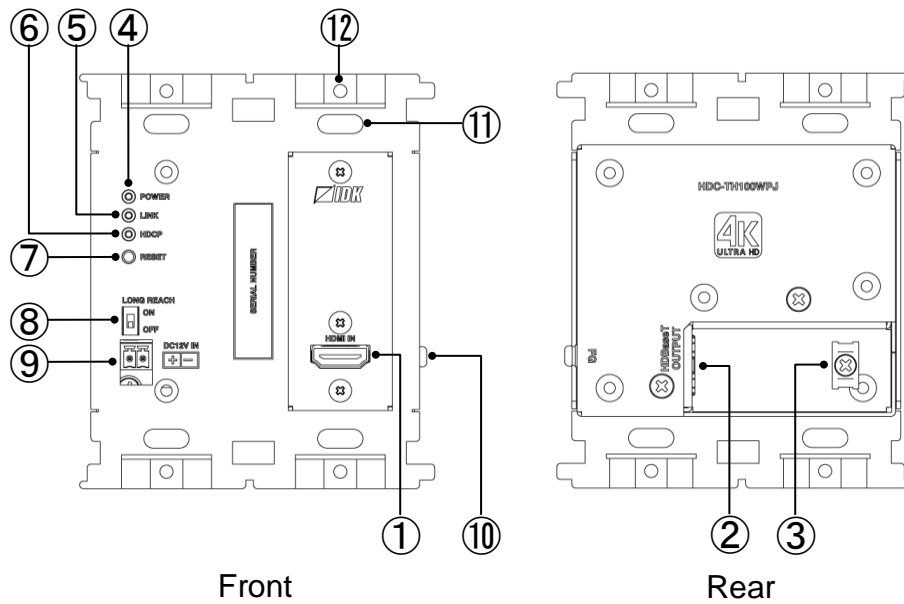

(In this figure, the left cover is removed.)

[Fig. 4.1] HDC-TH100WPJ drawing

[Table 4.1] HDC-TH100WPJ features

(1/2)

#	Feature	Description
①	HDMI input connector	Input connector for HDMI signals Connect to source devices such as Blu-ray disk players
②	HDBaseT output connector	Output connector for HDBaseT signal Connects to a receiver over a category cable. When using DC 12V power supply, do not be powered by PoH 【See: 6.1 Power supply】
③	Part for fixing category cable	Category cable that is connected to the HDBaseT output connector can be fixed with a zip tie. 【See: 7 Installation】

[Table 4.2] HDC-TH100WPJ features (Cont'd)

#	Feature	Description
④	POWER LED	Shows the power status Illuminates in green: Powered Does not illuminate : Not powered
⑤	LINK LED	Shows the connection status between the HDC and HDBaseT receiver Illuminates in green : The receiver is connected Blinks in green (0.5-second interval): The receiver is in standby state Does not illuminate : No connection
⑥	HDCP LED	Shows the HDCP status Illuminates in green: HDCP compliant Blinks in green : HDCP incompliant Does not illuminate : No video signal
⑦	RESET button	Resets the HDC and then re-establish the connection to HDBaseT receiver
⑧	LONG REACH switch	Enables/disables long reach mode of HDBaseT output for up to 1080p (24 bit) or dot clock 148 MHz ON : Enables long reach mode (Up to 492 ft. (150 m)) OFF : Disable long reach mode (Up to 328 ft. (100 m))
⑨	DC 12V IN (power input) connector	Connector for DC 12 V power supply When using PoH, do not use DC 12V power supply 【See: 6.1 Power supply】
⑩	Frame ground	Use for bonding chassis to local ground. An M3 screw is used.
⑪	Screw hole	Hole for installing the HDC to a switch box or the like
⑫	Screw hole	Hole for attaching a 2-gang decorator wallplate

Note:

For Long reach mode, up to 1080p (24 bit) resolutions are supported when using IDK's HDBaseT products supporting 328 ft. (100 m).

5 System configuration example

Example: Powered by PoH

Power is provided by the MSD-802UHD. Video of the laptop is output to the monitor.

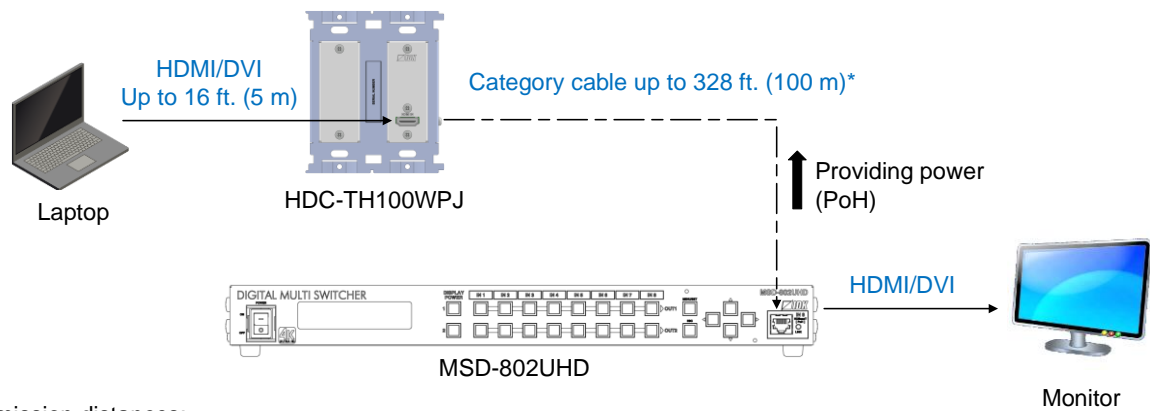

*Transmission distances:

Up to 328 ft. (100 m) : 4K@60

Up to 492 ft. (150 m) : 1080p (24 bit) (with Long reach mode, Use IDK's HDBaseT products supporting 328 ft. (100 m))

[Fig. 5.1] System configuration with PoH powered

Tip:

If using the PoH powering function of the MSD-802UHD, set "HDBaseT input power supply" to "ON". Refer to the MSD-701UHD/702UHD/801UHD/ 802UHD User Guide for details.

Note:

If transmitting DVI signal with HDCP from a source device, video may not be output to the sink device depending on connected devices. Contact us before transmitting DVI signal with HDCP.

6 Precautions

6.1 Power supply

The HDC can be powered by either of:

- From a device supporting PoH PSE (IEEE 802.3af)
or
- From DC 12 V power supply

Note:

When using PoH, do not use the DC 12V power supply.

■ **Powered from a device supporting PoH (PSE)**

Power is provided from a device supporting PoH over a category cable that is connected to an HDBaseT output connector. Turn all devices off when connecting to the category cable.

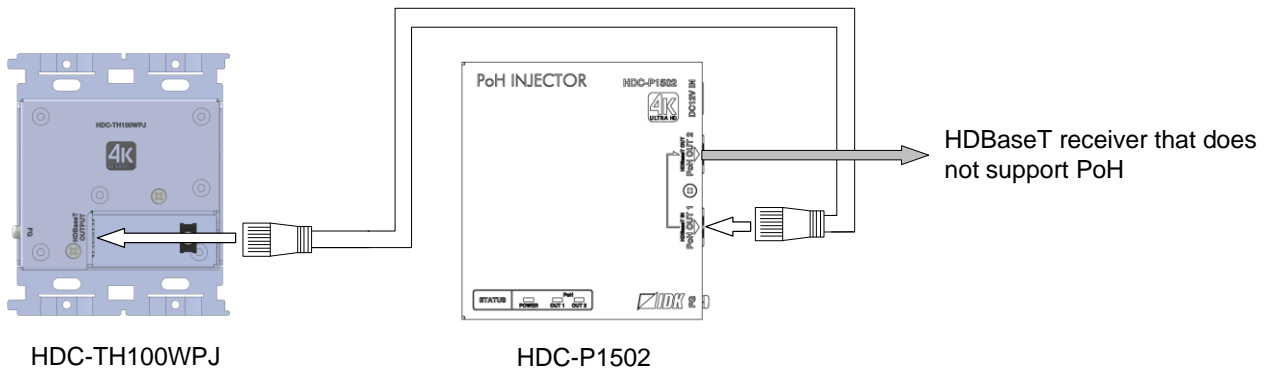

[Fig. 6.1] Powered from HDC-P1502

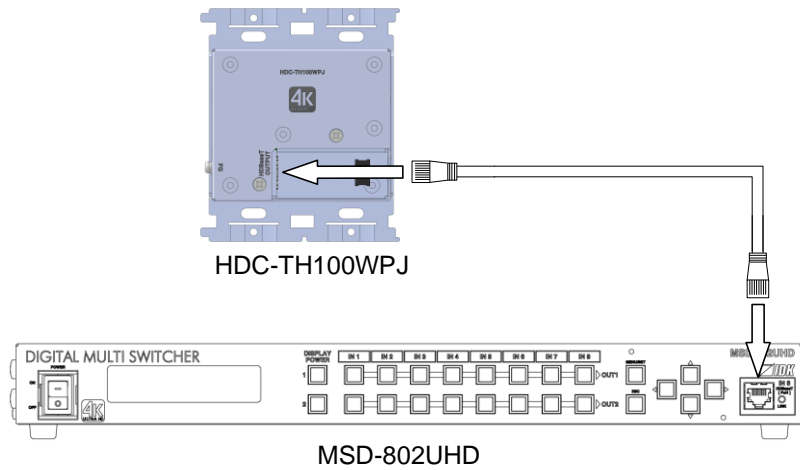

[Fig. 6.2] Powered from MSD-802UHD

■ **From DC 12 V power supply:**

Insert a non-energized power cable into the terminal block. Remove the left wallplate cover and connect the terminal block to the DC 12V IN connector. AWG28 to AWG16 conductor gauge is recommended. The recommended wire strip length is 0.28 in. (7 mm).

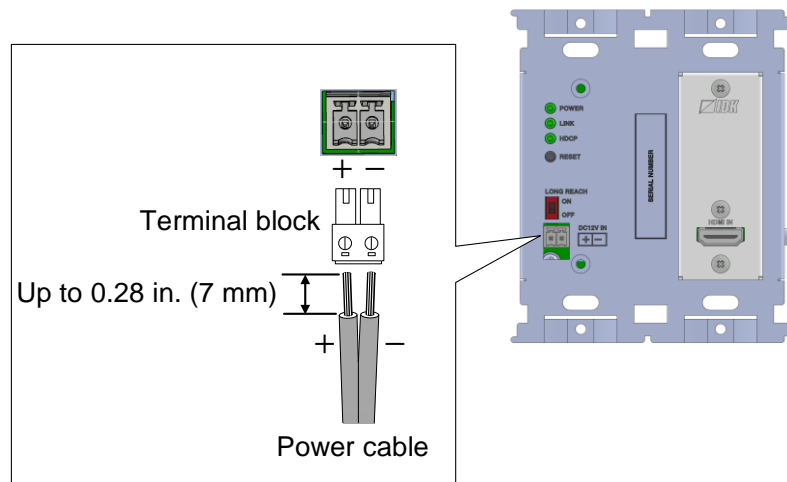

[Fig. 6.3] Connecting DC 12 V power cable

Note:

Ensure the polarity is correct when inserting the power cable to the terminal block. Otherwise, it may cause problems or a fire.

6.2 Cable

6.2.1 Category cable for extension

To ensure the best performance of category cables, select a correct category cable and connect it correctly.

- Cat5e UTP/STP and Cat6 UTP/STP can be used, but we recommend CAT.5E HDC cable* for optimal performance.
- If using an STP cable, connect the FG connector to a ground source. Otherwise, the shielding feature does not work correctly. When using a UTP cable, we still recommend using the ground connector.
- The shielded STP cables are less affected by interference or external noise than UTP cables.
- Connectors for long-haul transmission are the same as that of eight-core modular connector used for Ethernet, but the transmission system is not the same so that it cannot be connected to Ethernet.
- The maximum transmission distance of a category cables is the shorter distance of the maximum transmission distances of transmitter/receiver/sink device connected to the HDC.
- Pin assignments: T568A or T568B straight
- Do not pull the cable hard. The allowable tension of the category cable is 110 N.
- Do not bend the connection cable at a sharp angle. Keep the bend radius four times of the cable diameter or larger.
- Do not tie the cable tightly; leave a space allowing the cable to move slightly.
- If you use multiple category cables, we recommended keeping a distance between the cables or not to place the cables closely in parallel.
- Keep the category cable as straight as you can. If you coil the cable, it is easily affected by noise.
- Do not place the cable in an electrically noisy environment, since high-speed signals are transmitted. Particularly when you use a high-output radio around the HDC, video or audio may be interrupted.
- If the total transmission distance from the transmitter to receiver is 328 ft. (100 m) or less, up to two cable joints can be used. Products supporting Cat6A (10GBase-T) are recommended. However, the transmission distance of high-resolution transmission, such as 4K, may be shortened about 10%.
- Use AWG 24 or ticker cable for PoH.
- The table below shows supported transmission distance for each category. Note that the distance may shorten depending on the actual environment.

[Table 6.1] Transmission distance

Noise influence	Category		Transmission distance	TMD5 clock	Recommended cable
Easily affected	UTP	Cat5e	164 ft. (50 m)	≤ 225 MHz	For 164 ft. (50 m) or longer, CAT.5E HDC*, Cat5e STP, and Cat6 UTP/STP cables
		Cat6	328 ft. (100 m)		
				230 ft. (70 m)	
Less affected	STP	Cat5e* Cat6	328 ft. (100 m)	Long reach mode ≤ 148 MHz (1080p 24 bit or less)	For 4K format 230 ft. (70 m) or longer: CAT.5E HDC*, Cat5e STP, and Cat6 STP cables
			492 ft. (150 m)		

* The CAT.5E HDC cable is a double-shielded category cable that optimizes video signal transmission. It is certified to 500 MHz bandwidth at distance up to 330 ft. (100 m) and verified to meet requirements specified by HDBaseT Alliance. The double-shielded structure protects video signal from outside interference.

Note:

If there is a problem in the transmission path, video or audio may be interrupted. Check the precautions above. If the problem still cannot be solved, shortening the category cable may remedy the problem.

6.2.2 Cabling

When connecting the HDC to external devices, please observe the following precautions.

- Read manuals for the external devices.
- Before you connecting cables to the HDC or an external device, dissipate static electricity by touching grounded metal such as racks before handling signal cables. Failure to observe this precaution may result in ESD (electrostatic discharge) damage.
- Power all units off before connecting cables.
- Be sure to fully seat all plugs and connections and dress cables to reduce stress on connectors.

7 Installation

When installing the HDC, observe the following precautions:

- Ensure the category cable is fixed with a zip tie to protect the connector.
- Wall thickness: 0.6 in. (15 mm) or thicker
- When the HDC needs to be installed in an enclosed space or switch box, maintain the following sufficient clearances to provide adequate ventilation: 1 in. (25 mm) or more around the HDC or switch box; 0.2 in. (5 mm) or more for depth

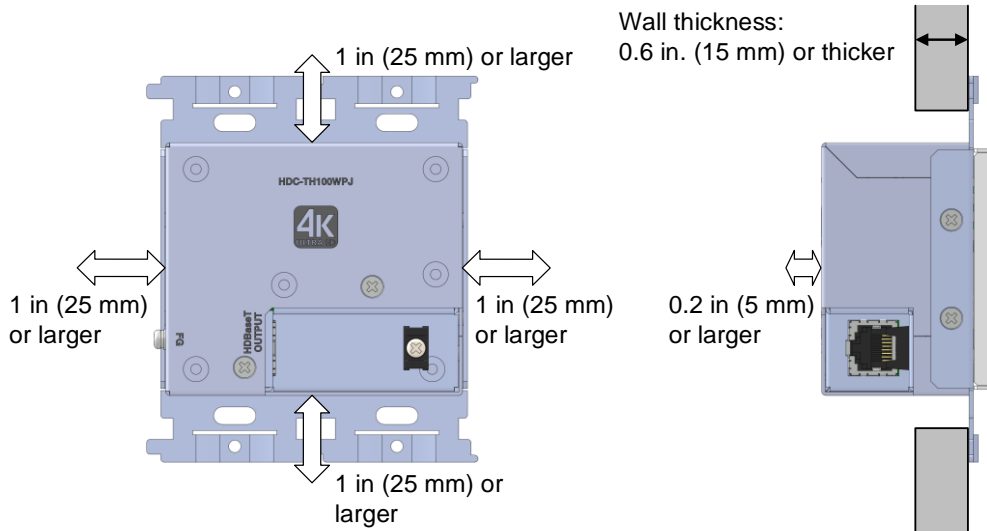

[Fig. 7.1] Space for heat dissipation

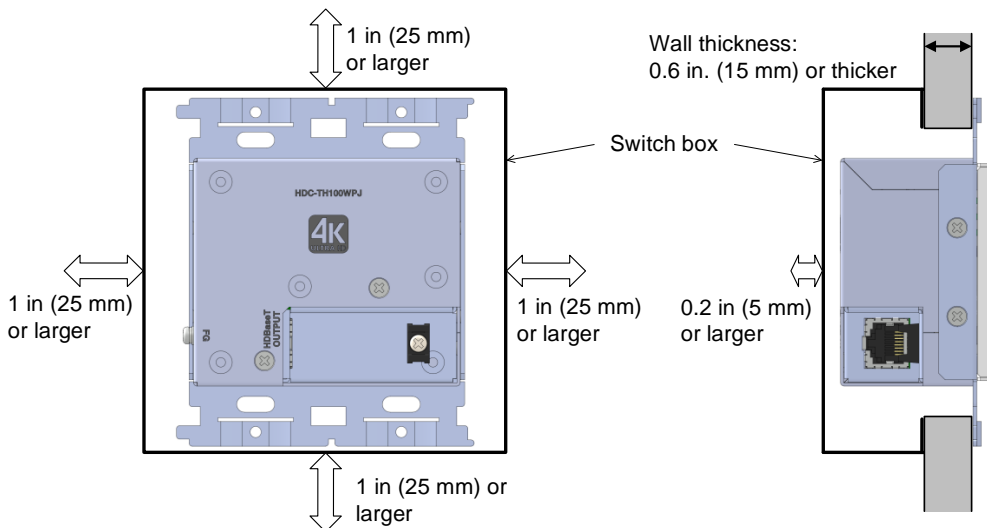

[Fig. 7.2] Space for heat dissipation (when switch box is used)

7.1 Switch box, bracket, and wallplate

IDK has confirmed that the following switch box, bracket, and wallplate can be mounted to the HDC.

- DS4912 (Panasonic)
- DF32221K (Panasonic)
- WN3997 (Panasonic)
- WN6006 (Panasonic)
- WN7606K (Panasonic)
- NKP-3UF-2 (Jimbo)

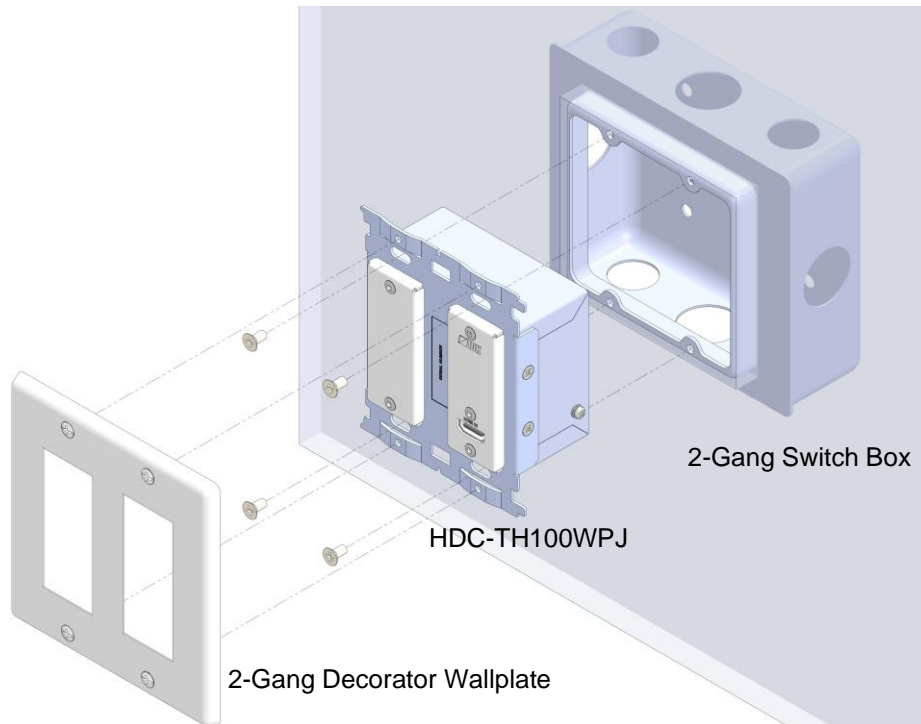

[Fig. 7.3] Example: Switch box is used

Note:

If installing the HDC directly in the wall without a switch box, use WN3997 (Panasonic)
WN3993020 (Panasonic) is not supported.

7.2 Replacing HDC wallplate cover

HDC wallplate cover (white) originally attached to HDC-TH100WPJ. You can replace the white cover with a black one (HDC-WPC-B) using a #1 Phillips screwdriver.

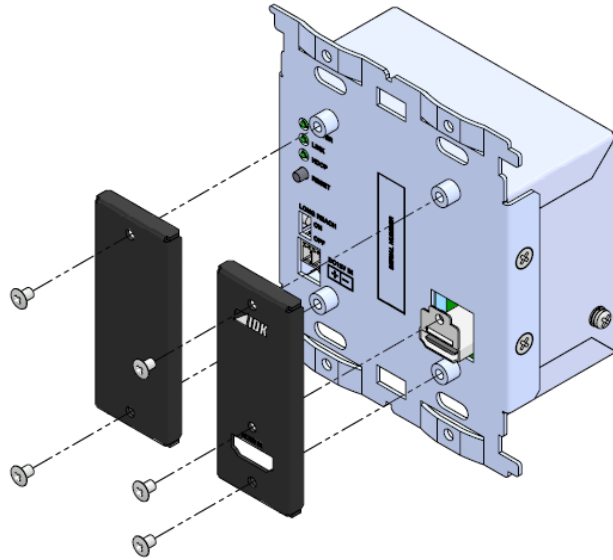

[Fig. 7.4] Replacing HDC wallplate cover

8 Product specification

Item	Description	
Input	1 input HDMI (*1)/DVI 1.0 TMDS signal link HDCP 1.4/2.2 (Pass through) (*2) CEC (Pass through) Connector: Female HDMI Type A (19-pin) (*3)	
Output	1 output HDBaseT PoH power supplied (PD) (equivalent to IEEE802.3af) Connector: RJ-45	
Format	VGA to 4K (*4) 480i / 480p / 576i / 576p / 720p / 1080i / 1080p / 4K (*4)	
Color depth	24 bit, 30 bit, 36 bit Deep Color (*5)	
Dot clock	25 MHz to 600 MHz	
TMDS clock	25 MHz to 340 MHz	
TMDS data rate	0.75 Gbps to 10.2 Gbps	
Plug & Play	Pass through	
Digital audio input / output	Multi-channel LPCM up to 8 channels Sampling frequency: 32 kHz to 192 kHz, Sample size: 16 bit to 24 bit	
Cable for extension	Cable (*6)	CAT.5E HDC, Cat5e UTP/STP, Cat6 UTP/STP
	Transmission distances (*7)	Up to 328 ft. (100 m) (For 4K format, CAT.5E HDC, Cat5e STP, or Cat6 STP cable is used) Up to 492 ft. (150 m) (Long reach mode is used)
General	Power	PoH power supplied (PD) (equivalent to IEEE 802.3af) (*8), Connector: RJ-45 or DC 12 V 0.2 A, Connector: 2-pin terminal block (*9)
	Power consumption	PoH power supplied (PD) : About 4 Watts DC 12 V power supplied : About 3 Watts
	Dimensions	3.7 (W) x 4.3 (H) x 1.9 (D)" (94 (W) x 110 (H) x 48.8 (D) mm) (Excluding connectors and the like)
	Weight	0.9 lbs. (0.4 kg)
	Temperature	Operating : 32°F to 104°F (0°C to +40°C) Storage : -4°F to +176°F (-20°C to +80°C)
	Humidity	Operating/Storage: 20% to 90% (Non Condensing)
	Switch Box	DS4912 (Panasonic) DF32221K (Panasonic)
	Mounting Bracket	WN3997 (Panasonic)
Wallplate	WN6006 (Panasonic) WN7606K (Panasonic) NKP-3UF-2 (Jimbo)	

*1 ARC and HEC are not supported.

*2 To transmit those signals, use an IDK's category cable extender supporting DVI signals.

If DVI signals with HDCP is sent from the source device, video may not be output to the sink device. Please check the operation beforehand.

*3 Use 16 ft. (5 m) or shorter HDMI cables.

For 4K format, use an 18-Gbps high speed cable.

*4 For 4K format, 24 Hz/25 Hz/30 Hz/50 Hz (4:2:0)/60 Hz (4:2:0) are supported.

*5 For 4K format, the following color depths are supported.

- 24 Hz/25 Hz/30 Hz : 24 bit (RGB, YCbCr 4:4:4)
- 24 Hz/25 Hz/30 Hz : 24 bit, 30 bit, 36 bit (YCbCr 4:2:2)
- 50 Hz/59.94 Hz/60 Hz : 24 bit (YCbCr 4:2:0)

*6 T568A or T568B straight. The CAT.5E HDC cable is developed by IDK and recommended by HDBaseT alliance.

*7 The maximum transmission distance was obtained when IDK's CAT.5E HDC cable was used. The distance may not be extended with some device combinations, cabling method, or other manufacturer's cable. Video may be disturbed or may not be output even if signals are within the range mentioned above. Operations may not be stable with some LCD devices; please check the operation beforehand or contact us.

The maximum transmission distance is the shorter distance of connected HDBaseT product or sink device's maximum transmission distance.

For Long reach mode, use IDK's category cable products that supports 328 ft. (100 m), and up to resolutions 1080p (24 bit) or less are supported.

*8 For receiving power, please use a category cable receiver that supports PoH power supply (IEEE 802.3af) or PoH injector. For providing power, use an AWG 24 or thicker category cable.

*9 PoH (powered) cannot be used together with DC 12 V power supply.

8.1 Dimensions

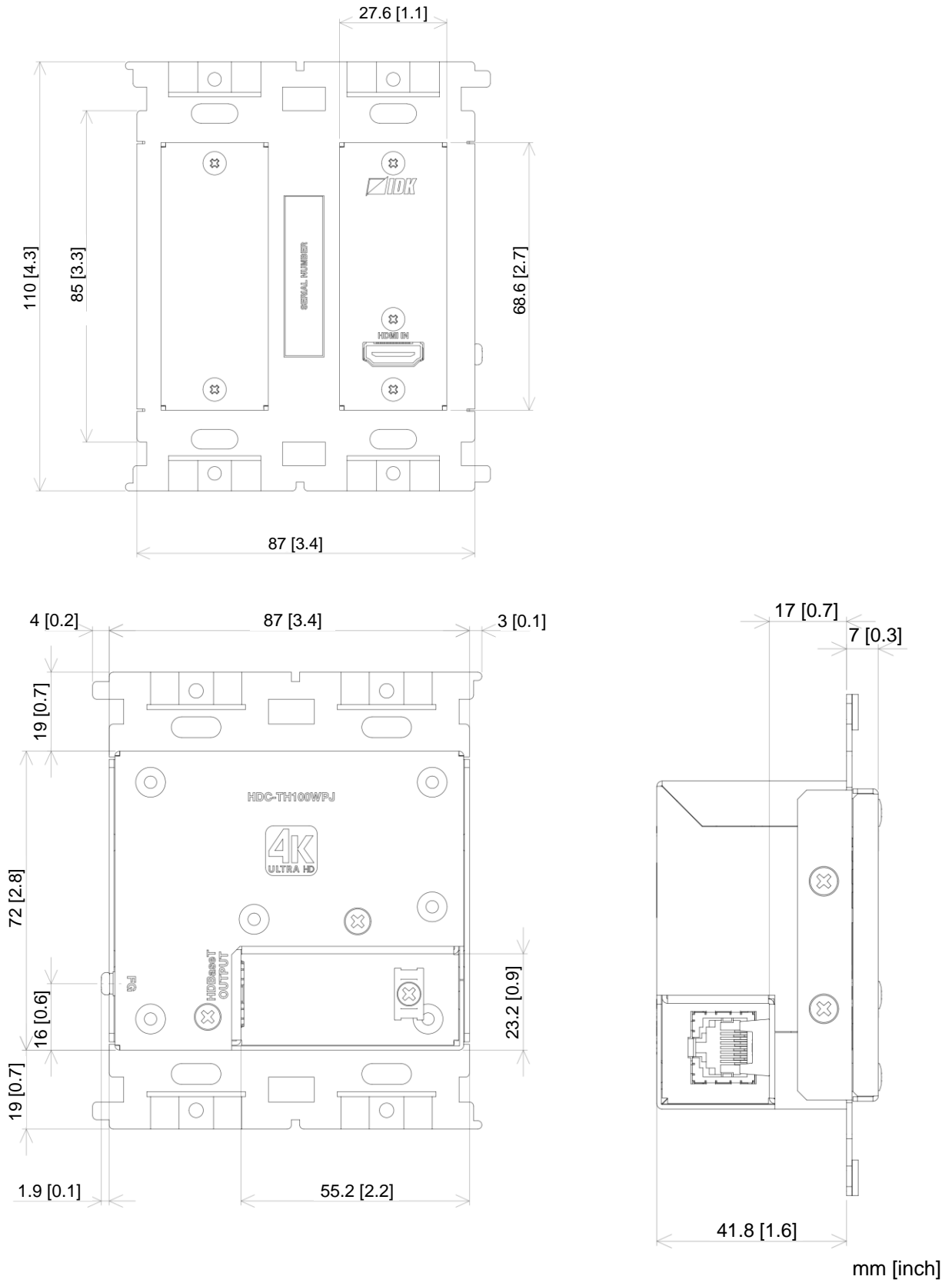

[Fig. 8.1] Dimensions

9 Troubleshooting

In case the HDC does not work correctly, please check the following items first. Also, refer to manuals for connected devices as well, since they may possibly be the cause of the problem.

- Are the HDC and all devices plugged in and powered on normally?
- Are cables connected correctly?
- Are there no loose connections?
- Are correct cables for HDC being used?
- Are signal specifications of connected devices matched to each other?
- Are settings of the sink devices correct?
- Are there any nearby objects that may cause noise?
- Operates correctly when connect devices using genuine cables without connecting of HDC?

If additional assistance is required, please contact us.

User Guide of HDC-TH100WPJ

Ver.1.1.0

Issued on: 16 February 2021



Headquarters

IDK Corporation
7-9-1 Chuo, Yamato-shi, Kanagawa-pref.
242-0021 JAPAN
TEL: +81-46-200-0764 FAX: +81-46-200-0765

Email: idx_eng@idx.co.jp

URL: <http://www.idxkav.com>

USA

IDK America Inc.
72 Grays Bridge Road Suite 1-C, Brookfield, CT 06804
TEL: +1-203-204-2445

Email: sales@idxkav.com

URL: <http://www.idxkav.com>

Europe

IDK Europe GmbH
Lise-Meitner-Str. 6, D-40878 Ratingen
TEL: +49-2102-578-301-0

Email: info@idxkav.eu

URL: <http://www.idxkav.com>



Product information Support

Arvanics Corporation
7-9-1 Chuo, Yamato-shi, Kanagawa-pref.
242-0021 JAPAN
TEL: +81-46-259-6920 FAX: +81-46-259-6930

Email: info@arvanics.com

URL: <http://www.arvanics.com>

Information in this document is subject to change without notice.

©2019 IDK Corporation, all rights reserved. All trademarks mentioned are the property of their respective owners.