

## USB-C to HDMI Converter

# IFC-V21U

Operation Guide

Ver.1.0.0

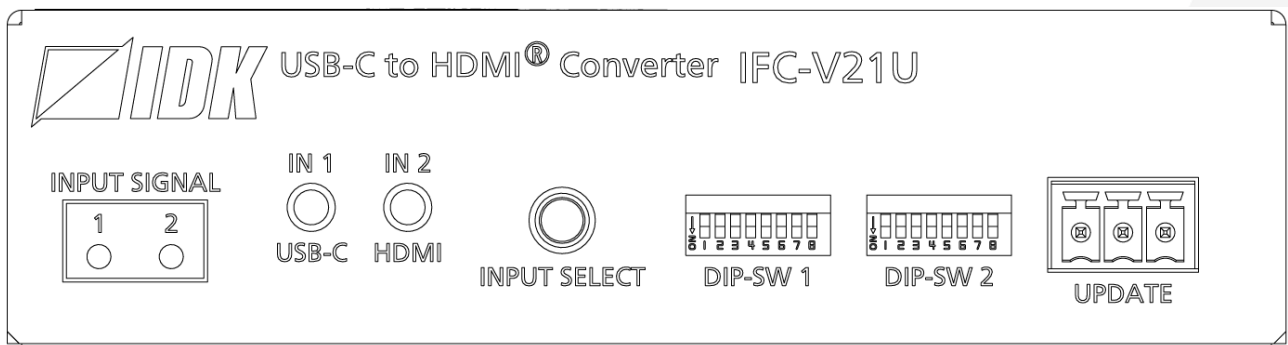

Thank you for choosing our product.

Please thoroughly familiarize yourself with this guide before installing this equipment. We recommend keeping this manual together with the equipment for future reference as needed.

- All rights reserved.
- Some information contained in this guide such as exact product appearance, communication commands, and so on may differ depending on the product version.
- This guide is subject to change without notice. You can download the latest version from IDK's website at: [www.idkav.com](http://www.idkav.com)

**About technical documentation**

■ **Please read the following guides before connecting this equipment to a power source.**

<p><b>1. Safety Instructions</b> Contains important safety instructions for the product to help ensure your own personal safety and protect the product and working environment from potential damage.</p>	<p>Provided with the product.</p>
<p><b>2. Setup Guide</b> Contains setup information and precautions for installing the product and connecting cables.</p>	<p>Download from <a href="http://www.idkav.com">www.idkav.com</a></p>

■ **Please refer to the following guides as needed.**

<p><b>3. Operation Guide</b> Describes how to configure and use the equipment.</p>	<p>Download from <a href="http://www.idkav.com">www.idkav.com</a></p>
<p><b>4. User Guide</b> Contains detailed explanation of functions, setting values, and restrictions.</p>	<p><a href="http://www.idkav.com">www.idkav.com</a></p>

**Trademarks**

- HDBaseT™ and the HDBaseT Alliance Logo are trademarks of the HDBaseT Alliance.
- The terms HDMI and HDMI High-Definition Multimedia Interface, and the HDMI Logo are trademarks or registered trademarks of HDMI Licensing Administrator, Inc. in the United States and other countries.
- SDVoE™ and SDVoE logo are trademarks of SDVoE Alliance.
- All other company and product names mentioned in this document are either registered trademarks or trademarks of their respective owners. In this document, the “®” or “™” marks may not be specified.
- ©2023 IDK Corporation, all rights reserved.

**FCC STATEMENT**

This equipment has been tested and found to comply with the limits for a Class A digital device, pursuant to part 15 of the FCC Rules. These limits are designed to provide reasonable protection against harmful interference when the equipment is operated in a commercial environment. This equipment generates, uses, and can radiate radio frequency energy and, if not installed and used in accordance with the instruction manual, may cause harmful interference to radio communications. Operation of this equipment in a residential area is likely to cause harmful interference, in which case the user will be required to correct the interference at his own expense.

**CE MARKING**

This equipment complies with the essential requirements of the relevant European health, safety and environmental protection legislation.

**WEEE MARKING**





Waste Electrical and Electronic Equipment (WEEE), Directive 2002/96/EC  
(This directive is only valid in the EU.)







This equipment complies with the WEEE Directive (2002/96/EC) marking requirement. The left marking indicates that you must not discard this electrical/electronic equipment in domestic household waste.

# Safety Instructions

Read all safety and operating instructions before using this product. Follow instructions and heed warnings/cautions.

Instructions and warnings/cautions for all products are provided. Some of them may not be applicable to your product.

	<h2>Warning</h2>	Indicates the presence of a hazard that may result in death or serious personal injury if the warning is ignored or the product is handled incorrectly.
	<h2>Caution</h2>	Indicates the presence of a hazard that may cause minor personal injury or property damage if the caution is ignored or the product is handled incorrectly.

Symbol	Description	Example
 Caution	This symbol is intended to alert the user. (Warning and caution)	 Hot surfaces Caution
 Prohibited	This symbol is intended to prohibit the user from specified actions.	 Do not disassemble
 Instruction	This symbol is intended to instruct the user.	 Unplug

## Warning

### For lifting heavy products:

 Instruction	<ul style="list-style-type: none"> <li>● <b>Lifting must be done by two or more personnel.</b></li> </ul> <p>To avoid injury: When lifting the product, bend your knees, keep your back straight and get close to it with two or more persons.</p>
--	--





### For installing and connecting products:

 Prohibited	<ul style="list-style-type: none"> <li>● <b>Do not place the product in unstable place.</b></li> </ul> <p>Install the product in a horizontal and stable place, as this may fall or tip over and cause injury.</p> <ul style="list-style-type: none"> <li>● <b>Secure the product if installing in the locations with vibration.</b></li> </ul> <p>Vibration may move or tip over the product unexpectedly, resulting in injury.</p>
---	--

# Warning

 <b>Instruction</b>	<ul style="list-style-type: none"> <li>● <b>Installation work must be performed by professionals.</b> The product is intended to be installed by skilled technicians. For installation, please contact a system integrator or IDK. Improper installation may lead to the risk of fire, electric shock, injury, or property damage.</li> <li>● <b>Insert the power plug into an outlet that is unobstructed.</b> Unobstructed access to the plug enables unplugging the product in case of any extraordinary failure, abnormal situation or for easy disconnection during extended periods of non-use.</li> <li>● <b>Insert the power plug into an appropriate outlet completely.</b> If the plug is partially inserted, arcing may cause the connection to overheat, increasing the risk of electric shock or fire. Do not use a damaged plug or connect to a loose outlet.</li> <li>● <b>Unplug the product from an AC power source during installation or service.</b> When connecting peripheral devices to this product, unplug all involved devices from outlets. Ground potential differences may cause fire or other difficulties.</li> <li>● <b>The product must be electrically earthed/grounded.</b> To reduce the risk of electric shock, ensure the product is connected to a mains socket outlet with a protective earthing connection.</li> <li>● <b>For PoE/PoH, use category cables meeting IEEE802.3af/at.</b> Otherwise, it may cause problems or a fire.</li> </ul>
---	--

**For operating products:**



 <b>Prohibited</b>	<ul style="list-style-type: none"> <li>● <b>Keep out any foreign objects.</b> To avoid fire or electric shock, do not permit foreign objects, such as metal and paper, to enter the product from vent holes or other apertures.</li> <li>● <b>For power cable/plug and Category cable,</b> <ul style="list-style-type: none"> <li>• Do not scratch, heat, or modify, including splicing or lengthening them.</li> <li>• Do not pull, place heavy objects on them, or pinch them.</li> <li>• Do not bend, twist, tie or clamp them together forcefully.</li> </ul> </li> </ul> <p>Misuse of the power cable and plug may cause fire or electric shock. If power cables/plugs become damaged, contact your IDK representative.</p>
 <b>Do not disassemble</b>	<ul style="list-style-type: none"> <li>● <b>Do not repair, modify or disassemble.</b> Since the product includes circuitry that uses potentially lethal, high voltage levels, disassembly by unauthorized personnel may lead to the risk of fire or electric shock. For internal inspection or repair, contact your IDK representative.</li> </ul>
 <b>Do not touch</b>	<ul style="list-style-type: none"> <li>● <b>Do not touch the product and connected cables during electric storms.</b> Contact may cause electric shock.</li> </ul>
 <b>Instruction</b>	<ul style="list-style-type: none"> <li>● <b>Clean the power plug regularly.</b> If the plug is covered in dust, it may increase the risk of fire.</li> </ul>

**If the following problem occurs:**





 <b>Unplug</b>	<ul style="list-style-type: none"> <li>● <b>Unplug immediately if the product smokes, makes unusual noise, or produces a burning odor.</b></li> <li>● <b>Unplug immediately if the product is damaged by falling or having been dropped.</b></li> <li>● <b>Unplug immediately if water or other objects are directed inside.</b></li> </ul> <p>If you continue to use the product under these conditions, it may increase the risk of electric shock or fire. For maintenance and repair, contact your IDK representative.</p>
--	--

# **Caution**

**For installing and connecting products:**

 <b>Prohibited</b>	<ul style="list-style-type: none"> <li>● <b>Do not place the product in a location where it will be subjected to high temperatures.</b> If the product is subjected to direct sunlight or high temperatures while under operation, it may affect the product's performance and reliability and may increase the risk of fire.</li> <li>● <b>Do not store or operate the product in dusty, oil smoke filled, or humid place.</b> Placing the product in such environment may increase the risk of fire or electric shock.</li> <li>● <b>Do not block the vent holes.</b> If ventilation slots are blocked, it may cause the product to overheat, affecting performance and reliability and may increase the risk of fire.</li> <li>● <b>Do not place or stack heavy items on the product.</b> Failure to observe this precaution may result in damage to the product itself as well as other property and may lead to the risk of personal injury.</li> <li>● <b>Do not exceed ratings of outlet and wiring devices.</b> Exceeding the rating of an outlet may increase the risk of fire and electric shock.</li> </ul>
 <b>No wet hands</b>	<ul style="list-style-type: none"> <li>● <b>Do not handle power plug with wet hands.</b> Failure to observe this precaution may increase the risk of electric shock.</li> </ul>
 <b>Instruction</b>	<ul style="list-style-type: none"> <li>● <b>Use and store the product within the specified temperature/humidity range.</b> If the product is used outside the specified range of temperature and humidity continuously, it may increase the risk of fire or electric shock.</li> <li>● <b>Do not place the product at elevations of 1.24 mi. (2,000 m) or higher above sea level.</b> Failure to do so may shorten the life of the internal parts and result in malfunctions.</li> <li>● <b>When mounting the product into the rack, provide sufficient cooling space.</b> Mount the product in a rack meeting EIA standards, and maintain spaces above and below for air circulation. For your safety as required, attach an L-shaped bracket in addition to the panel mount bracket kit to improve mechanical stability.</li> <li>● <b>Never insert screws without the rubber feet into the threaded holes on the bottom of the product.</b> Never insert screws alone into the threaded holes on the bottom of the product. Doing so may lead to damage when the screws contact electric circuitry or components inside the product. Reinstall the originally supplied rubber feet using the originally supplied screws only.</li> </ul>

**For operating products:**

 <p><b>Hot surfaces Caution</b></p>	<p><b>For products with the hot surfaces caution label only:</b></p> <ul style="list-style-type: none"> <li>● <b>Do not touch the product's hot surface.</b></li> </ul> <p>If the product is installed without enough space, it may cause malfunction of other products. If you touch product's hot surface, it may cause burns.</p>
 <p><b>Prohibited</b></p>	<ul style="list-style-type: none"> <li>● <b>Use only the supplied power cable and AC adapter.</b></li> <li>● <b>Do not use the supplied power cable and AC adapter with other products.</b></li> </ul> <p>If non-compliant adapter or power cables are used, it may increase the risk of fire or electric shock.</p>
 <p><b>Unplug</b></p>	<ul style="list-style-type: none"> <li>● <b>If the product won't be used for an extended period of time, unplug it.</b></li> </ul> <p>Failure to observe this precaution may increase the risk of fire.</p> <ul style="list-style-type: none"> <li>● <b>Unplug the product before cleaning.</b></li> </ul> <p>To prevent electric shock.</p>
 <p><b>Instruction</b></p>	<ul style="list-style-type: none"> <li>● <b>Do not prevent heat release.</b></li> </ul> <p>If cooling fan stops, power off the product and contact IDK. Failure to do so may raise internal temperature and increase the risk of malfunction, fire, or electric shock.</p> <ul style="list-style-type: none"> <li>● <b>Keep vents clear of dust.</b></li> </ul> <p>If the vent holes near the cooling fan or near the fan are covered with dust, internal temperatures increase and may increase the risk of malfunction. Clean the vent holes and near the fan as needed. If dust accumulates inside of the product, it may increase the risk of fire or electric shock. Periodic internal cleaning, especially before humid rainy season, is recommended. For internal cleaning, contact your IDK representative.</p>

## Contents

<b>About this Guide</b> .....	<b>8</b>
<b>Conventions</b> .....	<b>8</b>
<b>About this Product</b> .....	<b>9</b>
<b>Provided items</b> .....	<b>9</b>
<b>Panel overview</b> .....	<b>10</b>
<b>Precautions for Installation</b> .....	<b>11</b>
<b>Connection Details</b> .....	<b>12</b>
<b>Connecting USB-C devices</b> .....	<b>12</b>
<b>Connecting HDMI devices</b> .....	<b>13</b>
<b>Front Panel Operations</b> .....	<b>14</b>
<b>Switching input channel</b> .....	<b>14</b>
<b>Changing settings using DIP switch</b> .....	<b>14</b>
<b>Troubleshooting</b> .....	<b>15</b>

## About this Guide

---

This guide describes how to configure and use the IFC-V USB-C to HDMI Converter.

---

## Conventions

- The following terms are used in this guide.
  - PC : Personal computer
- The following notifications are used in this guide.
  - Note** : Addresses practices not related to personal injury, such as restrictions and attention.



## About this Product

---

The IFC-V21U converts DisplayPort Alternate Mode signals of USB-C to HDMI at resolutions up to 4K@60. The converter includes two inputs, one (1) USB-C and one (1) HDMI, and a single HDMI output. One of the inputs is output in HDMI format.

Using the IFC-V21U provides a simple way to convert USB-C to HDMI and can be paired with IDK's wide variety of HDMI products.

---

## Provided items

Ensure that all items illustrated below are included in the package.

If any items are missing or damaged, please contact IDK.

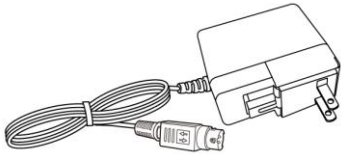

One (1) AC adapter (4 ft. (1.2 m))

## Panel overview

### Front panel

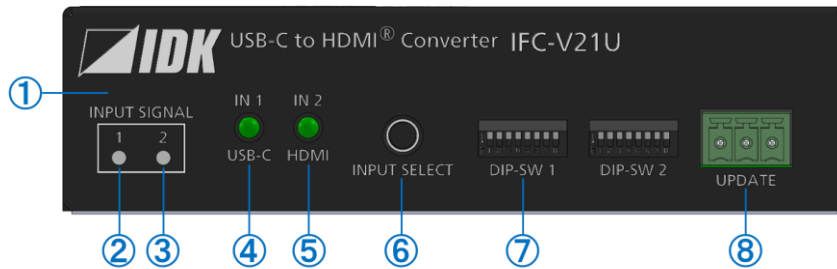

①	Front panel	User accessible button, DIP switch, UPDATE connector, and input signal status LED
②	IN1 input signal LED	Shows IN1(USB-C) input signal status. Lighted : USB-C signal is input Not lighted : No signal
③	IN2 input signal LED	Shows IN2(HDMI) input signal status. Lighted : HDMI signal is input Not lighted : No signal
④	IN1 USB-C LED	Shows which signal is selected for IN1(USB-C). Lighted : Selected Not lighted : Not selected
⑤	IN2 HDMI LED	Shows which signal is selected for IN2(HDMI). Lighted : Selected Not lighted : Not selected
⑥	Input selection buttons	Selects inputs.
⑦	DIP switch	Sets settings.
⑧	UPDATE	For maintenance. Do not use this connector.

### Rear panel

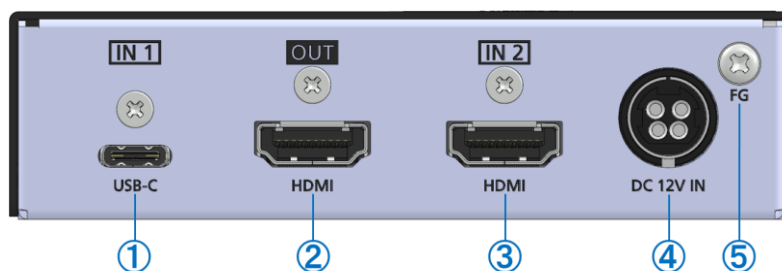

①	USB-C input	④	DC input
②	HDMI output	⑤	Frame ground (M3 screw)
③	HDMI input		

## Precautions for Installation

- Grounding (Earthing) is required. Connect the FG (Frame Ground) connector to a local electrical ground bonding point.
- When installing the IFC-V, observe the following precautions; otherwise, the internal temperature increases, possibly affecting product reliability and operation.
  - Do not stack or place one IFC-V directly on top of another IFC-V.
  - Do not block vent holes.
  - Maintain sufficient clearances around the IFC-V (1.2 in. (30 mm) or more) to provide adequate ventilation.
  - It is advisable to install the IFC-V in an environment compatible with the maximum temperature indicated in the specification sheet 32°F to 104°F (0°C to +40°C).
- Insert the DC plug into the power inlet connector of the IFC-V until it clicks.  
Hold the connector as illustrated below when unplugging the DC plug.

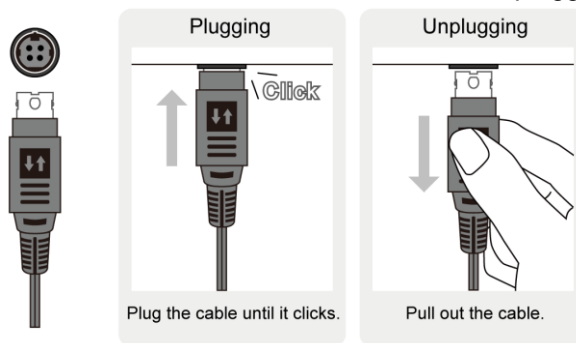

## Connection Details

When connecting the IFC-V to external devices, observe the following precautions.

### Notes

- Before connecting cables to the IFC-V or an external device, dissipate static electricity by touching grounded metal such as equipment racks before handling signal cables. Failure to observe this precaution may result in ESD (electrostatic discharge) damage.
- Power off or disconnect all related devices before connecting cables.
- Be sure to fully seat all plugs and connections and dress cables to reduce stress on connectors.

### Cable Lacing Bracket (FB-01 For IDK products only)

Use the cable lacing bracket to secure a standard HDMI or USB-C cable as shown.

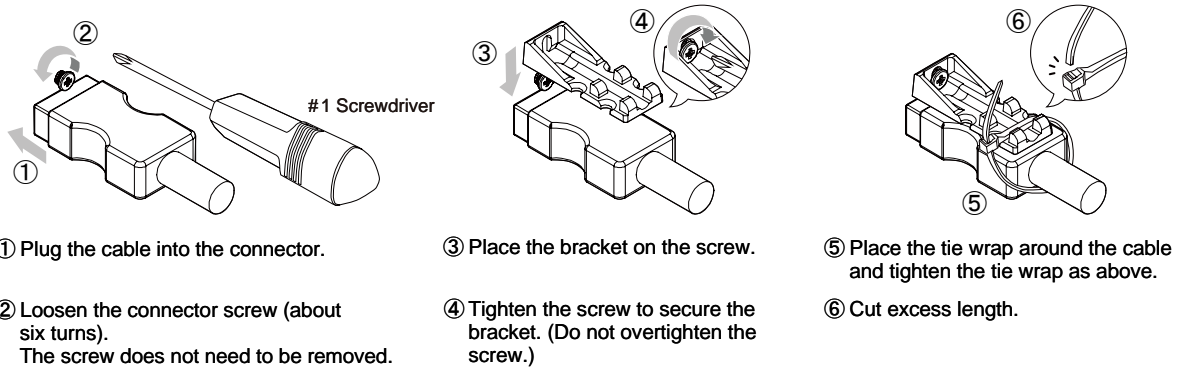

## Connecting USB-C devices

Connect the IFC-V to USB-C devices using USB-C cable.

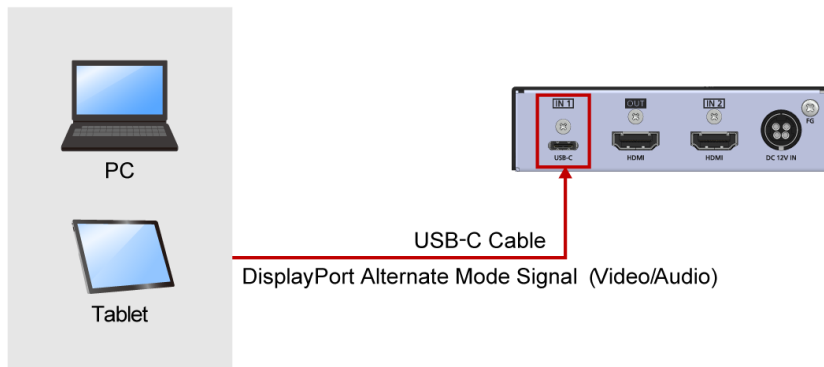

### Notes

- Video may be interrupted or may not be output depending on cable type, cable quality, cabling condition, connected device type, and installation environment.
- A problem may occur if a cable joint is used for USB-C cable extension.

## Connecting HDMI devices

Connect the IFC-V to HDMI devices using HDMI cables.

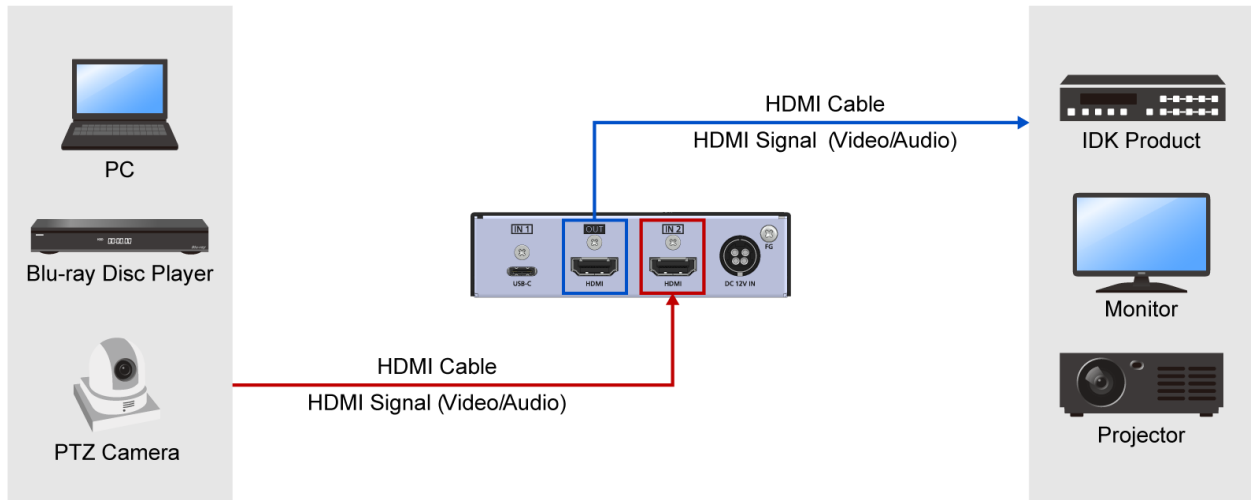

### Notes

- Video may be interrupted or may not be output depending on cable type, cable quality, cabling condition, connected device type, and installation environment.
- A problem may occur if a cable joint is used for HDMI cable extension.

## Front Panel Operations

This chapter contains information on the front panel operation.

### Switching input channel

1. Press the INPUT SELECT button to switch USB-C/HDMI input channel.  
The selected LED lights solid green.

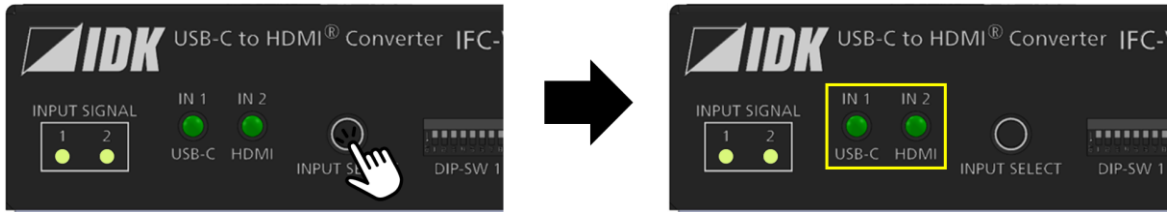

### Changing settings using DIP switch

1. Slide a switch (No.1 to 8) upwards (OFF) or downwards (ON).

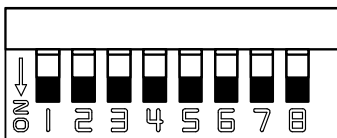
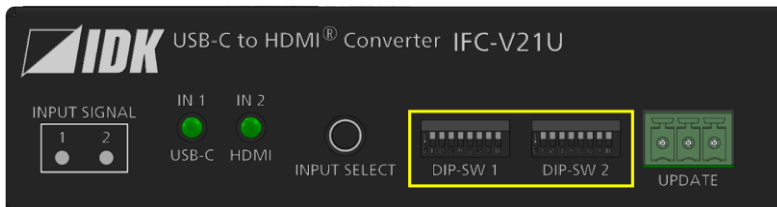

## Troubleshooting

---

This chapter provides recommendations in case difficulties are encountered during IFC-V setup and operation.

In case the IFC-V does not work correctly, please check the following items first.

- Are the IFC-V and all devices connected to an active power source and are they powered on?
- Are signal cables connected correctly?
- Are there any loose or partially mated connections?
- Are the interconnecting cables specified correctly to support adequate bandwidth?
- Are specifications of connected devices matched to each other?
- Are configuration settings for the connected devices correct?
- Is there any nearby equipment that may cause electrical noise/RF interference?

Use the IFC-V built-in status display features to check for input signal presence and format. Also use the status display features to check for the presence of connected sink devices as well as for EDID and HDCP compatibility.

If difficulties persist, please refer to the peripheral device manuals as well, since connected equipment may be the cause of the trouble.

If the trouble persists, please contact us after checking the following items.

- Does the problem occur with all the signal connectors?
- Does the problem occur when you connect the source and display devices directly, bypassing the IFC-V?

USB-C to HDMI Converter

# IFC-V21U

Operation Guide



[www.idkav.com](http://www.idkav.com)

## Headquarters

IDK Corporation

7-9-1 Chuo, Yamato, Kanagawa, 242-0021, JAPAN

TEL: +81-46-200-0764 FAX: +81-46-200-0765

Email: [idk\\_eng@idk.co.jp](mailto:idk_eng@idk.co.jp)

## USA

IDK America Inc.

72 Grays Bridge Road Suite 1-C, Brookfield,  
CT 06804, United States

TEL: +1-203-204-2445

Email: [sales@idkav.com](mailto:sales@idkav.com)

## Europe

IDK Europe GmbH

Lise-Meitner-Str. 6, D-40878 Ratingen, Germany

TEL: +49-2102-578-301-0

Email: [info@idkav.eu](mailto:info@idkav.eu)

## Vietnam

IDK Corporation Vietnam

Hanoi Representative Office

TEL: +84-247-108-8866

Email: [info\\_en@idk.co.jp](mailto:info_en@idk.co.jp)

IDK Corporation Vietnam

Ho Chi Minh Representative Office

TEL: +84-28-7108-8954

Email: [info\\_en@idk.co.jp](mailto:info_en@idk.co.jp)