



---

# Presentation Switch Pro with HDBaseT Extender

*User Manual*

*English*

---



No. 38281

[lindy.com](http://lindy.com)



## Introduction

Thank you for purchasing the Lindy Presentation Switch Pro with HDBaseT Extender. This product has been designed to provide trouble free, reliable operation. It benefits from both a LINDY 2 year warranty and free lifetime technical support. To ensure correct use, please read this manual carefully and retain it for future reference.

The Lindy Presentation Switch Pro is designed to allow many different video inputs including audio to be switched and extended at the same time. It is an ideal addition to any meeting or conference room, lecture hall or auditorium. For added flexibility the Switch is provided with a 70m HDBaseT Receiver to reach remote displays and projectors.

## Package Contents

- Presentation Switch Pro
- 70m HDBaseT Receiver
- Mounting ears
- Remote Control
- IR Receiver Cables
- IR Emitter Cables
- 1x 24V / 1A Power Adapter (5.5mm / 2.1mm) with UK, EU, AUS and US adapters
- 1x RCA x3 (Female) to VGA (Male) Cable
- This Manual

## Features

- HDMI 2.0, HDCP 2.2 and 1.4 compliant
  - DisplayPort 1.2a compliant
  - Mirrored HDBaseT 70M output via included receiver
    - 4K 30Hz, RGB, 8bit with 40m of Cat.6 cable
    - 1920x1080, 60Hz, RGB, 8Bit with 70m of Cat.6 cable
    - Dimensions: 115x17x65mm (4.53x0.67x2.56in)
  - HDMI / DisplayPort video input resolution up to 4K 60Hz (4:4:4)
  - VGA input resolution up to 1920x1200 60Hz
  - Output of up to 4k 30Hz via local and remote HDMI
  - HDBaseT receiver is powered by the transmitter using PoH
  - Supports automatic and manual switching modes
  - Supports EDID management
  - Supports pass-through of PCM 2CH
  - Control via Touch Panel buttons, Web GUI, IR remote, Terminal block contacts and RS-232
-

## Specification

- **Input ports:** 3x HDMI 2.0, DisplayPort 1.2a and VGA, 5x Stereo Terminal blocks, 1x Mic Terminal Block
- **Output ports:** 1x HDMI, 1x HDBaseT, 1x Stereo Terminal block
- **Control Ports:** 1x IR in, 1x IR out, 1x Contact Terminal block (6pin), 1x RS-232 terminal block, 1x RJ-45, 1x USB Type A (firmware upgrade)
- Supports up to 18 Gbps / 600Mhz bandwidth
- Supported Resolutions
  - HDMI / DisplayPort up to 3840x2160 60Hz 4:4:4 8bpc (30Hz output)
  - VGA up to 1920x1200 60Hz
  - HDBaseT up to 3840x2160 30Hz
- PCM stereo pass-through formats
- Optional phantom power for mic input
- HDCP 2.2 and 1.4 compatible
- Colour: Black
- Power Consumption: Main unit: 9W, HDBaseT Receiver: 9W
- Operating Temperature: 0°C - 40°C (32°F - 104°F)
- Storage Temperature: -20°C - 60°C (-4°F - 140°F)
- Relative humidity: 20 – 90% RH (non condensing)

## Installation

## Front Panel:

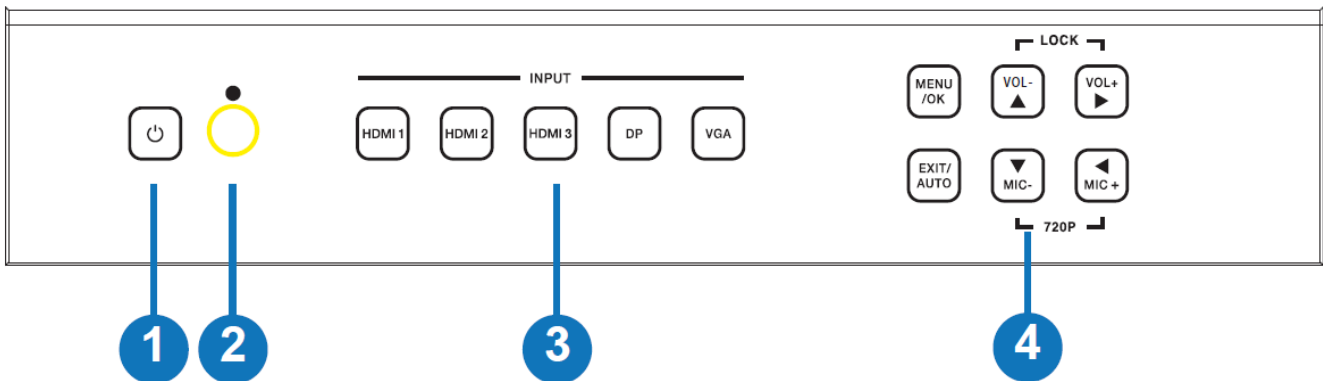

- 1 **Power button and indicator:**  
When this device is in standby mode the indicator will illuminate red. When switching the unit on, the indicator will illuminate blue.
- 2 **IR Window:**  
IR signal from remote control.
- 3 **Input Source & Auto buttons:**  
Press these buttons for source selection.  
The active source will be illuminated to corresponding indicator on the front panel.

**4 Operation buttons:**

- Pressing “OK/MENU” button enters the OSD. Then navigate using the 4-way arrow buttons. A new OSD setting is confirmed by pressing the “OK/MENU” button.
- Pressing "EXIT/AUTO" will exit the OSD. Press "EXIT/AUTO" for 5 seconds to auto switching on/off. When the button LED light is on, this means auto switching is on.
- Pressing the “MIC-/+" button decreases or increases MIC volume. Pressing the “VOL+/-“ button increases or decreases “Master volume”.
- Pressing both “MIC-“ and “MIC+” buttons simultaneously will reset the HDMI/HDBT output resolution to 720P 60Hz.
- Pressing both “VOL-“ and “VOL+” buttons simultaneously will lock / unlock the front panel, these two button LEDs will light on when the front panel is lock on.

**Rear Panel:**

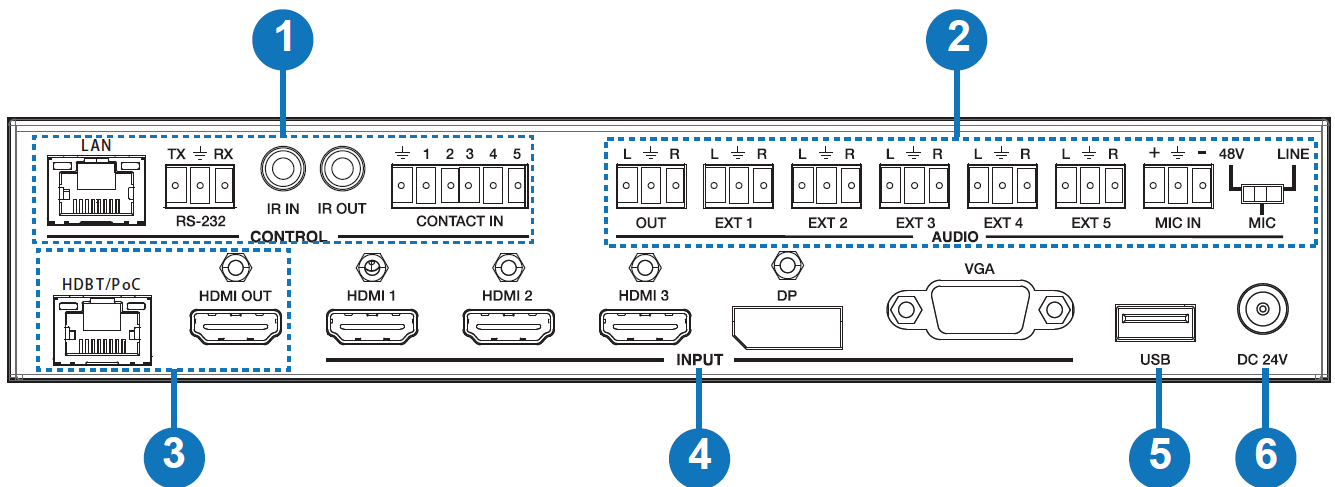

**1 Control ports:**

- **LAN:** This port is for Web GUI control; connect to an active Ethernet link with an RJ45 terminated cable.
- **RS-232:** Serial control port, connects with a control device to control the switch or it can be used as an extender to control another device connected with the HDBaseT receiver.
- **IR IN:** Connect the IR receiver cable to receive IR signals sent by the IR remote or this can be used to extend IR signals to the HDBaseT receiver.
- **IR OUT:** Connect the IR emitter cable. Used for controlling the local source device or the switch.
- **CONTACT IN:** This input control is reserved for direct source selection. Connect the ground pin (marked as  $\perp$  on panel) with following pin number for individual source selection.

Pin number	Source
Pin 1	HDMI1
Pin 2	HDMI2
Pin 3	HDMI3
Pin 4	DisplayPort
Pin 5	VGA/YPbPr/CVBS

## 2 Audio Ports:

- **OUT:** The audio comes from the input audio corresponding to the selected video source and mixed with MIC audio.
- **HDMI1/2/3/DP:** The external analog audio input for the respective input.
- **VGA:** The external analog audio input for the VGA input.
- **MIC IN:** Plug a microphone in to mix with the current audio source.
- **PHANTOM ON/OFF:** Slide the switch to “OFF” for a condenser or dynamic microphone, or to “ON” for professional 48V phantom microphones.

## 3 Output Ports:

- **HDBT Out:** Connects to the HDBaseT Receiver with PoH functionality.
- **HDMI Out:** Connects to a HDMI display or AV Receiver for video and/or audio output.

## 4 Input Ports:

- These video input ports include 3 x HDMI inputs, 1 x Display Port input & 1 x VGA input. The VGA port supports VGA, YPbPr and CVBS formats. The Factory default is VGA.

## 5 USB Port:

Reserved for future firmware upgrades

## 6 Power:

Plug the 24V DC power supply into the unit and connect the adaptor to an AC socket.

---

## Operation

**Main OSD MENU**

The Main MENU includes Picture, Aspect ratio, Screen, Audio setup, Network, System and Software update options.

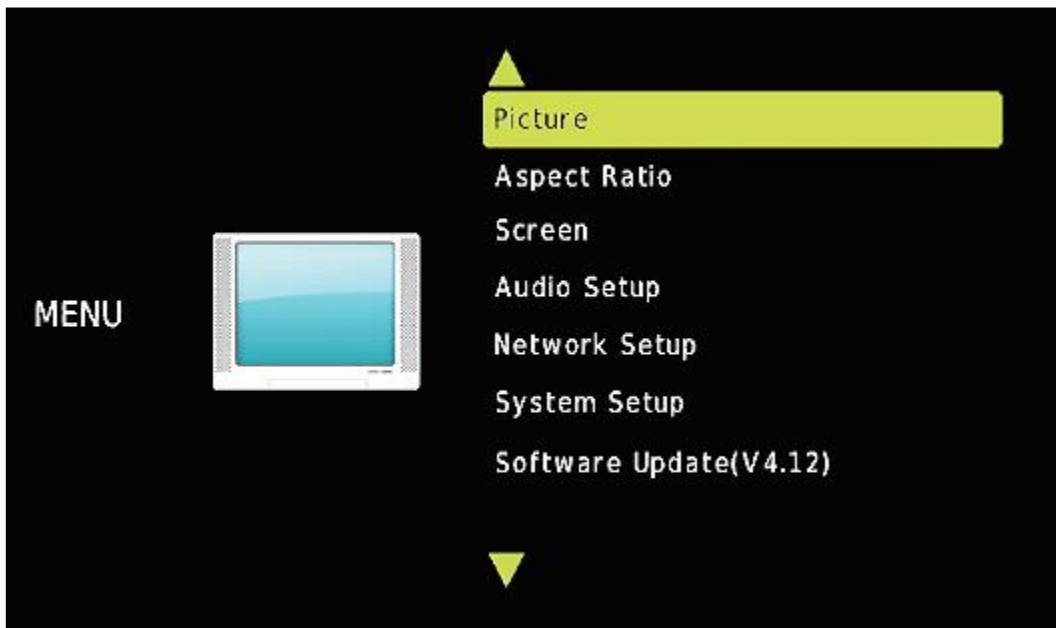
**Picture**

The picture MENU adjusts the picture quality.

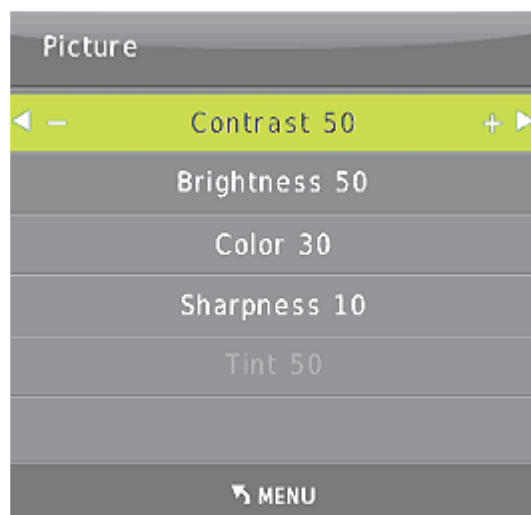

Contrast 0-100 (default 50),  
Brightness 0-100 (default 50),  
Color 0-60 (default 30),  
Sharpness 0-20 (default 10),  
Tint 0-100 (default 50, for CVBS NTSC format only)

**Aspect Ratio**

Provides the ability to adjust the picture output aspect ratio to 4:3 or 16:9/10.

**Screen**

The screen MENU is only for the VGA input. You can adjust horizontal, vertical position, size and phase.

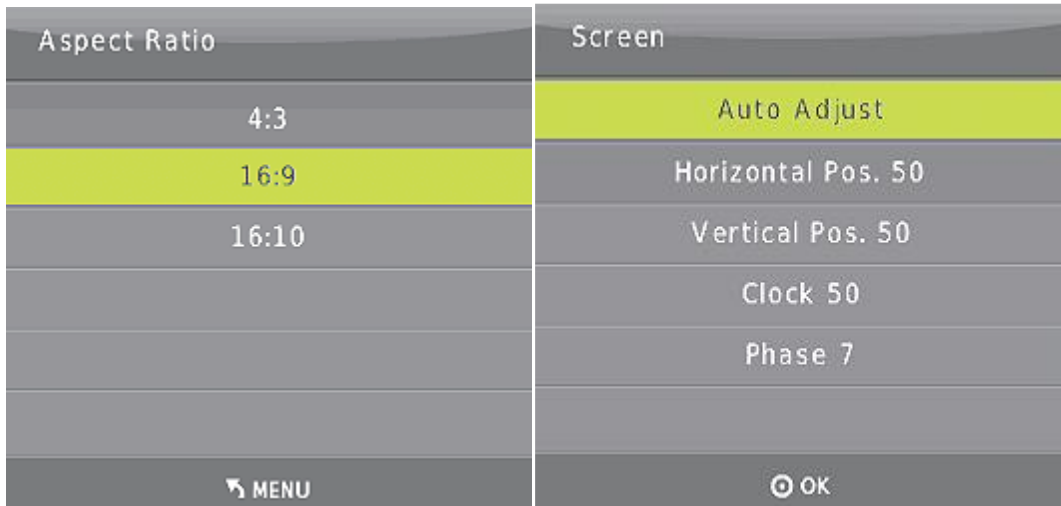

**EDID**

The EDID MENU adjusts HDMI and DisplayPort inputs only.

EDID1.4	4K2K30,PCM 2.0
EDID2.0	4K2K60,PCM 2.0
EDID From HDMI	EDID copy from local HDMI port
EDID From HDBT	EDID copy from HDBaseT Receiver HDMI port
EDID AUTO	Auto compare HDMI and HDBT Receiver HDMI port EDID

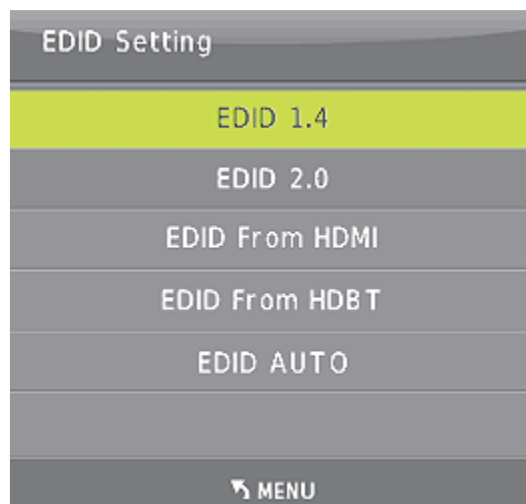



**Audio Setting**

The Audio Setting MENU switches between Embedded or External analog audio for each HDMI and DP input port.

**MIC mixer on:** The switch will mix the source audio and MIC audio to the audio output (HDMI, HDBT, Audio output port).

**MIC mixer auto:** The switch will reduce the source audio volume automatically when it detects the MIC audio input.

**MIC mixer off:** The switch will mute the MIC input audio.

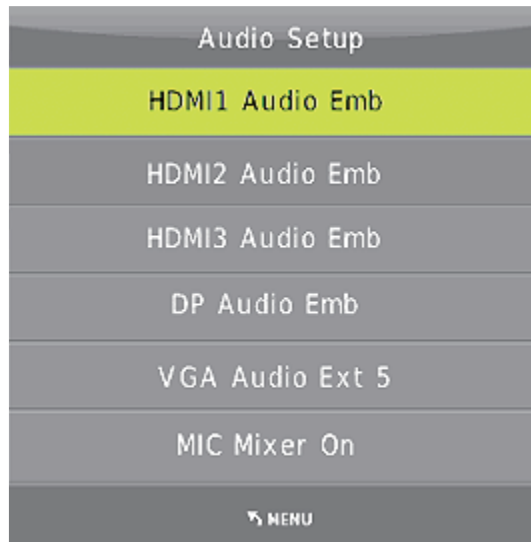

**Network**

The network MENU will display the IP address and allow either a DHCP or static IP to be set.

**Resolution**

The switch supports multiple HDMI output resolutions. Press the “RES” button on the IR remote, the resolution menu will be displayed. Then select a suitable resolution for your HDTV or monitor. **Auto** means that the HDMI resolution is based on the EDID information read from the display device.

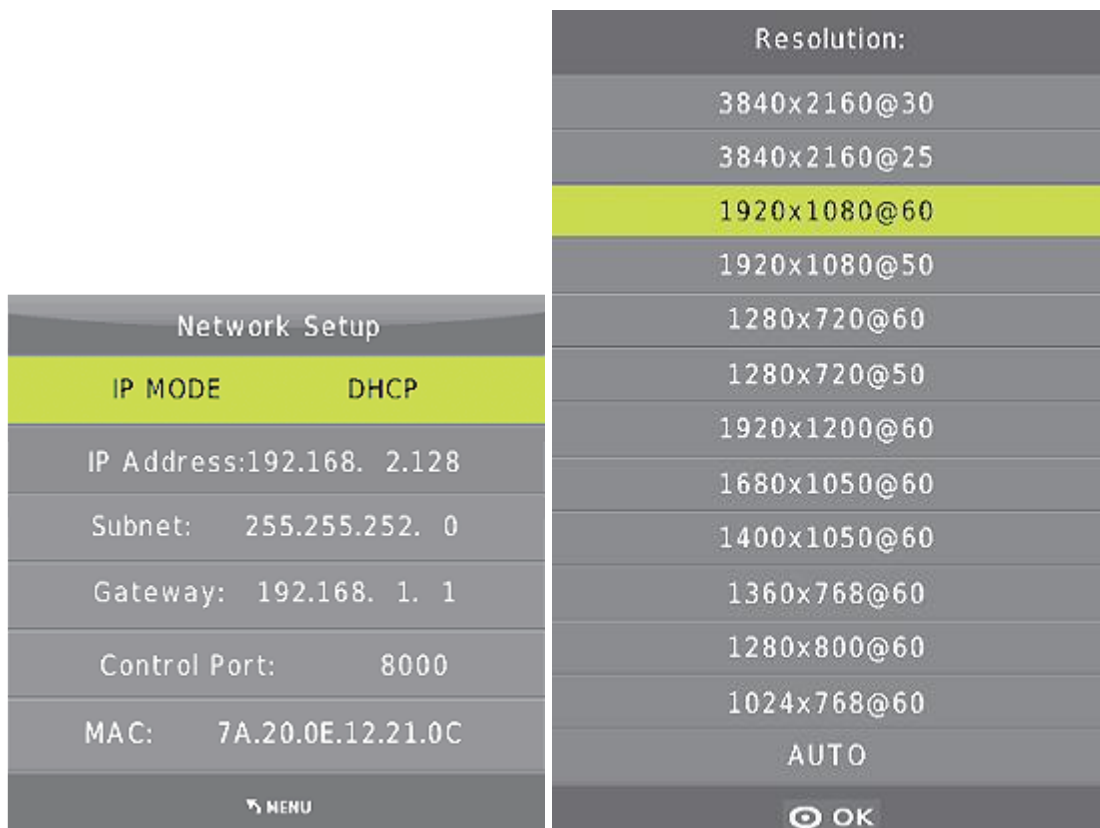

Remote Control



**Power:** Press this button to power on the switch or turn to standby mode.

**INPUT:** Press these buttons to select the input source.

**ADJ:** Press this button to operate the VGA input auto adjustment function

**RES:** Press this button to select the HDMI output resolution. (Press and hold 5 seconds or more and the HDMI output resolution will reset to 720p 60Hz.)

**Menu operation buttons:**

**MENU:** Press this button to enter the OSD menu.

**EXIT:** Press this button to exit the OSD menu.

**OK:** Press this button to confirm the operation.

**UP/DOWN/LEFT/RIGHT buttons:** Selection operation.

**VOLUME:** Control master audio volume.

**MIC:** Control MIC input audio volume.

**1) Control far-end device locally**

To control the switch or a remote display device by using the corresponding remote controller.

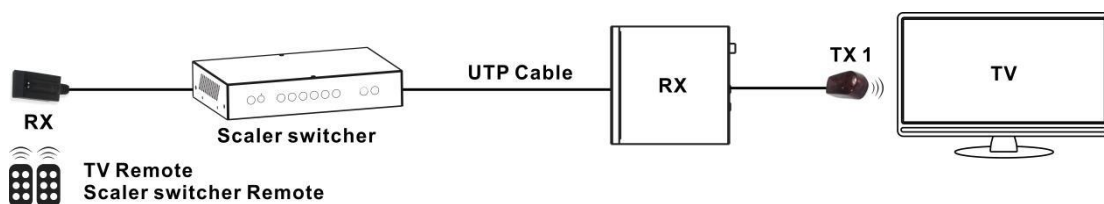

**2) Control local device from remote**

To control the switch or local source device by using the corresponding remote controller.

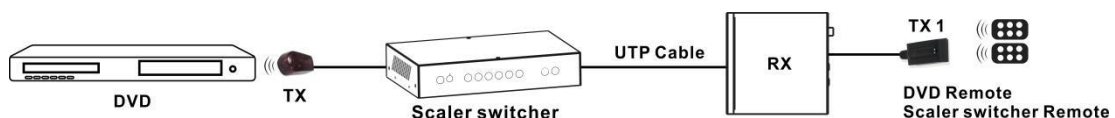

### 3) IR (20KHz---60KHz) cable pinout

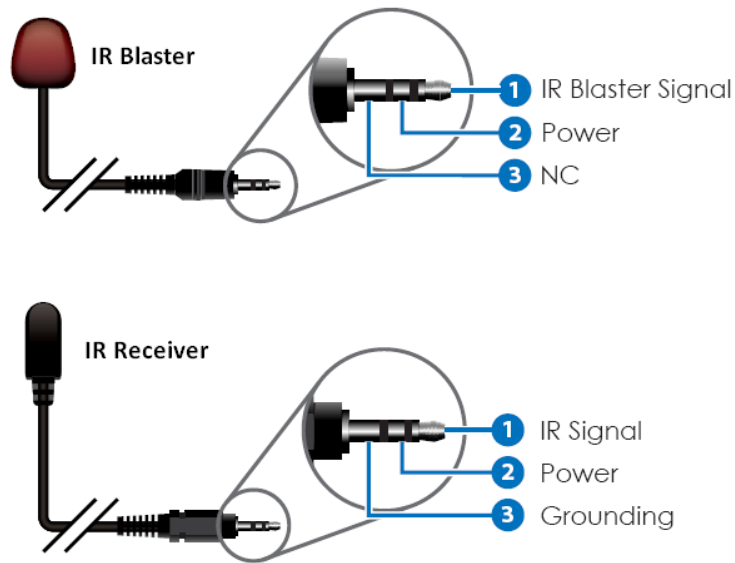

### Auto-Switching function

The switch has auto-switching and manual-switching modes. When in auto-switching mode, it will follow the following principles:

**New input:** Once a new input signal is detected, the switch will switch to this new signal automatically.  
**Power reboot:** The switch offers the function to remember the signal last used before power off. Once rebooted, it will automatically enter auto-switching mode, and then detect all inputs and memorise their connection status for future reboots. If the last used input signal is still available, then it will choose that signal. If not, it will detect all input signals with priority on HDMI1->HDMI2->HDMI3->DP->VGA (YPbPr/CVBS).

**Removed Signal:** Once the current signal is removed, the switch will detect all input signals with priority on HDMI1->HDMI2->HDMI3->DP->VGA (YPbPr/CVBS). It will transfer the first signal detected to the output.

Notice: The Auto-switching function works only when there is a new input signal or if an input signal is removed.

### VGA/YPbPr/CVBS input

The VGA input port is a multiple format port. It supports VGA/YPbPr/CVBS input signals. The switch will auto detect the input signal type and format. You can use the converter cable for YPbPr or CVBS signal inputs.

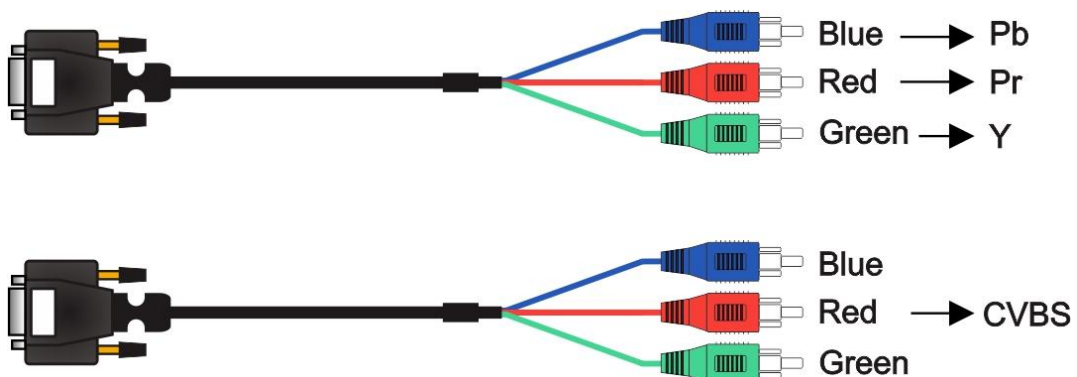

Connection of Microphone

The switch provides one 2-level microphone input to accommodate different microphone input modes, including 48V phantom power mode and MIC mode.

When switched to "ON" (It has a good frequency characteristics, high input impedance and high sensitivity in this mode), the MIC input will provide 48V phantom power. This should only be used for 48V condenser microphones.

1) Unbalanced connection:

"+" and "GND" connect to ground, and "-" connects to signal.

"-" and "GND" connect to ground, and "+" connects to signal.

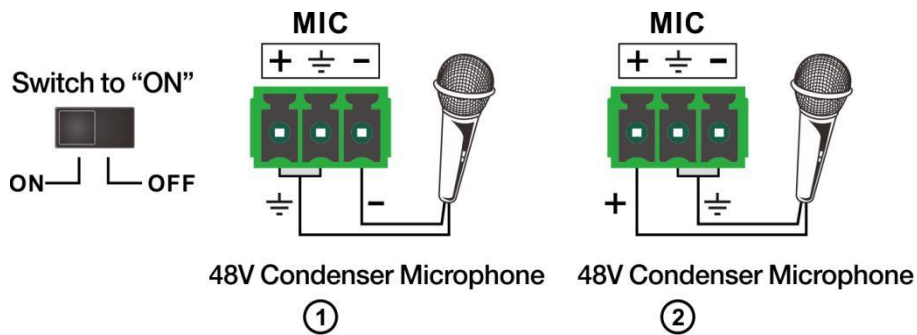

2) Balanced Connections: "+" connects to positive, "-" connects to negative and "GND" to ground.

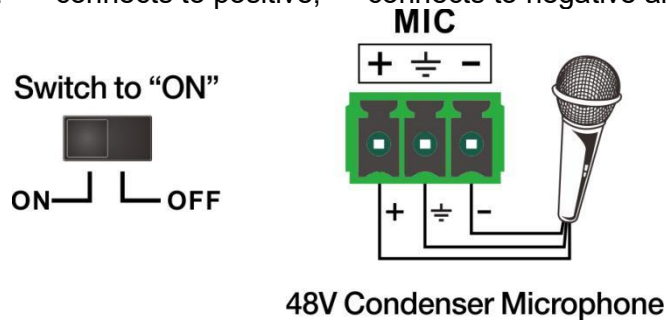

When switched to "OFF" (It has low frequency characteristics and wide frequency response in this mode), the microphone input is used for connecting dynamic and condenser microphones. There are two different connections:

1) Unbalanced connection:

"+" and "GND" connect to ground, and "-" connects to signal.

"-" and "GND" connect to ground, and "+" connects to signal.

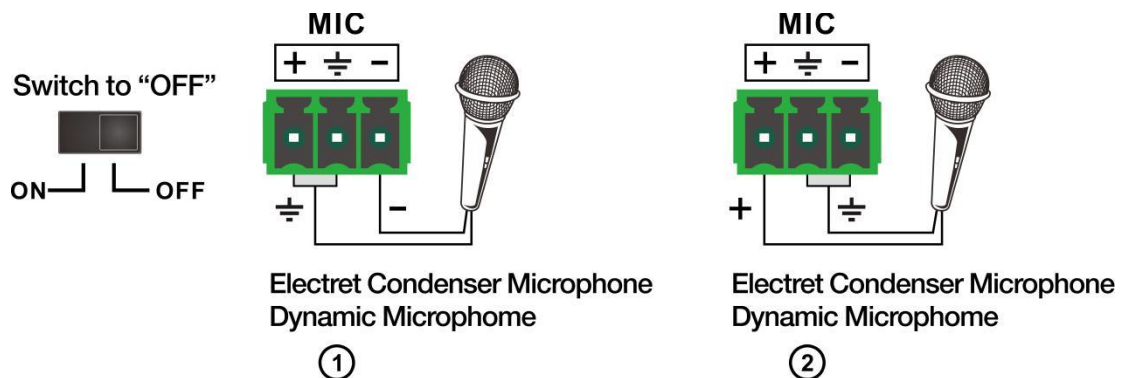

2) Balanced connection: “+” connects to positive, “-” connects to negative and “ $\text{⏏}$ ” connects to ground.

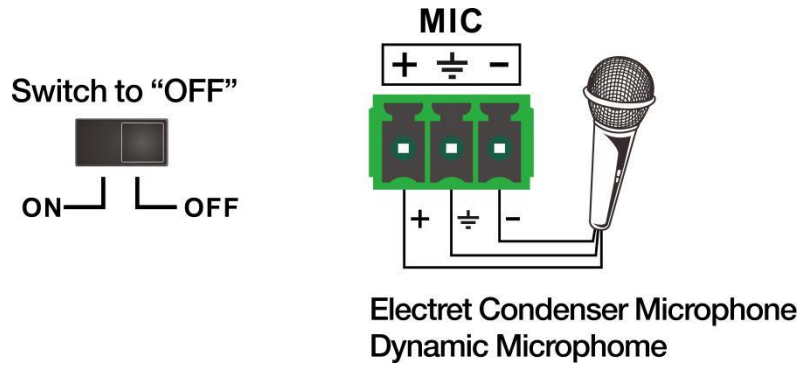

**Operations of RS-232 Control**

As RS-232 can be transmitted bi-directionally between the switch and the HDBaseT receiver, it is able to control a third-party RS-232 device locally or control the switch bi-directionally.

**1) Control the Switch or 3rd Party Device from the local side**

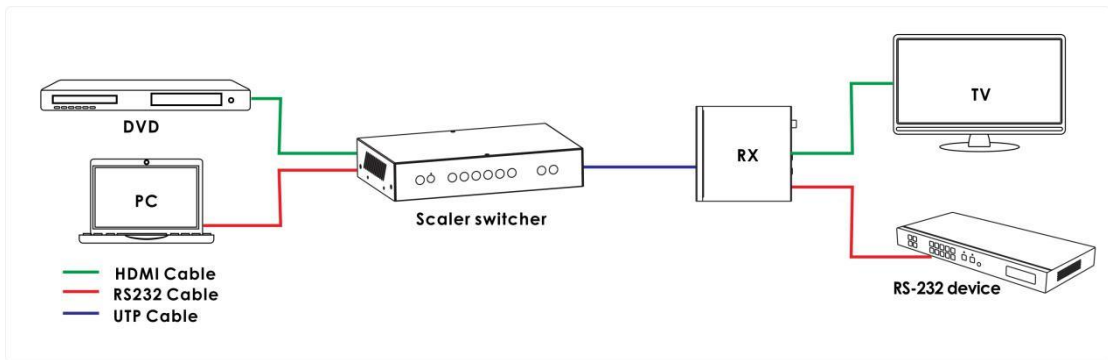

**2) Control the Switch or 3rd Party Device from remote Receiver**

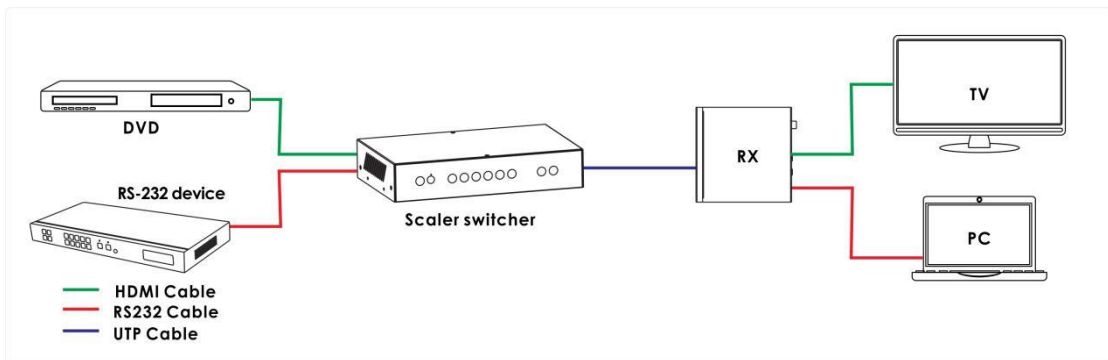

### 3) RS-232 Control

Please connect the switch with a computer that has been installed with the RS-232 control software. The interface of the control software is shown as below:

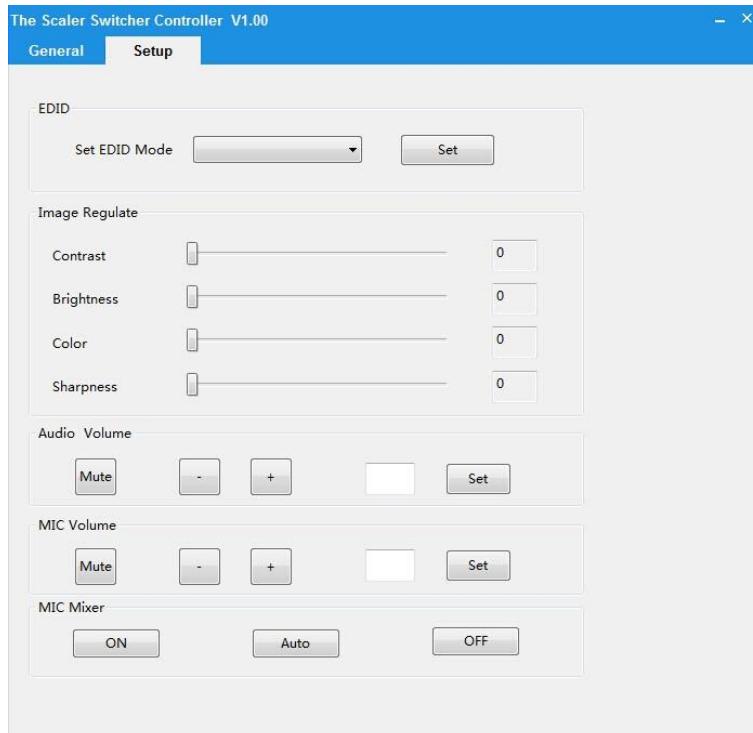
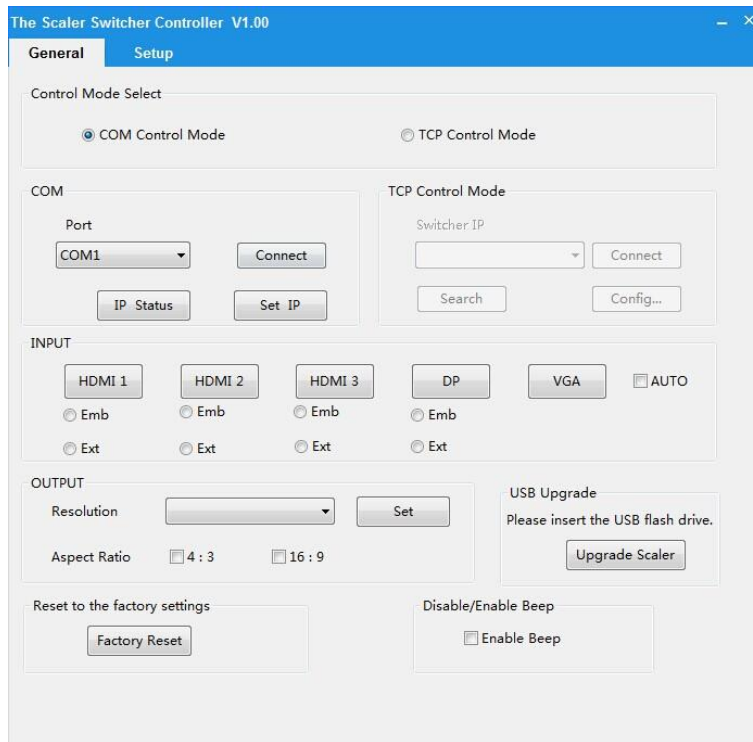

Custom serial commands are also available below:

Command	Description
help!	Display all communication commands
s factory reset!	Return to factory reset setting
r version!	Read current FW version
xyz!	Upgrade the switch FW
r power!	Read the switch power on/off status
s power on!	Power on the switch
s power off!	Power off the switch
r lock!	Read the switch panel lock status
s lock on!	Lock on the panel control
s lock off!	Lock off the panel control
s beep on!	Enable the switch Beep
s beep off!	Disable the switch Beep
r source!	Read current input source
s source 1!	Switch HDMI1 input(1:HDMI1,2:HDMI2, 3:HDMI3,4:DisplayPort,5:VGA/YBPBR/C-VIDEO)
r auto switch!	Read auto switch function status
s auto switch mode 1!	Enable auto switch function(1: Last connected source mode, 2: First connected source mode, 3: Priority source mode)
s auto switch off!	Disable auto switch function
r output!	Read output resolution
s output 1!	Setup output resolution at 3840x2160@30Hz (1:3840x2160@30Hz,2:3840x2160@25Hz, 3:1920x1080@60Hz,4:1920x1080@50Hz, 5:1280x720@60Hz,6:1280x720@50Hz, 7:1920x1200@60Hz,8:1680x1050@60Hz, 9.1400x1050@60Hz,10.1360x768@60Hz, 11.1280x800@60Hz,12.1024x768@60Hz, 13.Out display EDID native resolution
r hdcp!	Read HDMI/HDBT output hdcp enable status
s hdcp bypass!	Set HDMI/HDBT output to hdcp pass through mode
s hdcp 1.4!	Set HDMI/HDBT output to hdcp1.4 version
r contrast!	Read picture contrast status
s contrast 0!	Setup picture contrast 0(range:0-100)
r brightness!	Read picture brightness status
s brightness 0!	Setup picture brightness 0(range:0-100)
r color!	Read picture color status
s color 0!	Setup picture color 0(range:0-60)
r sharpness!	Read picture sharpness status
s sharpness 0!	Setup picture sharpness 0(range:0-20)
r tint!	Read picture tint status
s tint!	Setup picture tint 0(range:0-100,for CVBS NTSC format only)
r aspect ratio!	Read current input source output picture aspect ratio

s aspect ratio 1!	Setup current input source output picture aspect ratio at 16:9 (1: 16:9 , 2: 4:3, 3:16:10 )
r h size!	Read current input source output horizontal overscan value
s h size X!	Set output horizontal over scan to (100+X)%(the default X value is 0 and the range is -10~10,the value is set for current input source. )
r v size!	Read current input source output vertical overscan value
s v size X!	Set output vertical over scan to (100+X)%(the default X value is 0 and the range is -10~10,the value is set for current input source.)
r edid!	Read switch input port EDID status
s edid 1!	Setup input port EDID at HDMI1.4 standard (1: EDID1.4,2:EDID2.0,3: EDID copy HDMI 4:EDID copy HDBT,5:EDID AUTO)
s vga auto!	Enable VGA auto adjust function
r vga hpos!	Read VGA horizontal position
s vga hpos up!	Setup VGA horizontal position up
s vga hpos down!	Setup VGA horizontal position down
r vga vpos!	Read VGA vertical position
s vga vpos up!	Setup VGA vertical position up
s vga vpos down!	Setup VGA vertical position down
r vga clock!	Read VGA input ADC sampling clock value
s vga clock up!	Increase VGA input ADC sampling clock value
s vga clock down!	Decrease VGA input ADC sampling clock value
r vga phase!	Read VGA picture phase
s vga phase up!	Setup VGA picture phase up
s vga phase down!	Setup VGA picture phase down
r mixer!	Read MIC mixer status
s mixer on!	Setup mic mixer on
s mixer off!	Setup mic mixer off
s mixer auto!	Setup mic mixer auto
s auto vol!	Set source audio volume when set to mixer auto mode
r auto vol!	Read source audio volume when set to mixer auto mode
r fade in time!	Read source audio fade in time when set to mixer auto mode
s fade in time 1000!	Setup source audio fade in time when set to mixer auto mode. (The fade in time range is 0~5000ms.)
r fade out time!	Read source audio fade out time when set to mixer auto mode
s fade out time 1000!	Setup source audio fade out time when set to mixer auto mode (The fade out time range is 0~5000ms.)
r out vol!	Read output audio volume
s out vol 0!	Setup output audio volume 0(0~32)
s out vol up 1!	Increase output audio volume 1 level
s out vol down 1!	Decrease output audio volume 1 level
r mic vol!	Read mic volume



s mic vol 0!	Setup mic volume 0(0~32)
s mic vol up 1!	Increase mic input audio volume 1 level
s mic vol down 1!	Decrease mic input audio volume 1 level
s mic mute on!	Mute mic input audio
s mic mute off!	Un-mute mic input audio
s audio mute on!	Mute source input audio
s audio mute off!	Un-mute source input audio
s mute on!	Mute source and mic input audio
s mute off!	Un-mute source and mic input audio
r hdmi1 audio!	Read HDMI1 audio source
s hdmi1 audio 0!	Choose audio source as HDMI1 audio input (0: Emb,1: Ext1,2: Ext2,3:Ext3,4:Ext4,5:Ext5)
r hdmi2 audio!	Read HDMI2 audio source
s hdmi2 audio 0!	Choose audio source as HDMI2 audio input (0: Emb,1: Ext1,2: Ext2,3:Ext3,4:Ext4,5:Ext5)
r hdmi3 audio!	Read HDMI3 audio source
s hdmi3 audio 0!	Choose audio source as HDMI3 audio input (0: Emb,1: Ext1,2: Ext2,3:Ext3,4:Ext4,5:Ext5)
r dp audio!	Read Displayport audio source
s dp audio 0!	Choose audio source as Displayport audio input (0: Emb,1: Ext1,2: Ext2,3:Ext3,4:Ext4,5:Ext5)
r vga audio!	Read Displayport audio source
s vga audio 1!	Choose audio source as VGA audio input (1: Ext1,2: Ext2,3:Ext3,4:Ext4,5:Ext5)
r ip mode!	Read IP mode
s ip mode 1!	Setup IP mode at Static (1:Static,2:DHCP)
r ip addr!	Read IP address
s ip addr 192.168.1.255!	Setup IP address at 192.168.1.255
r subnet!	Read subnet
s subnet 255.255.255.252!	Setup subnet at 255.255.255.252
r gateway!	Read gateway
s gateway 192.168.1.1!	Setup gateway at 192.168.1.1
r port!	Read control port
s port 8000!	Setup control port at 8000
r sleep time!	Read switch sleep time(no signal to standby mode time)
s sleep time 1!	Set switch sleep time(no signal to standby mode time) (1: OFF , 2: 15seconds, 3: 1minutes ,4: 5minutes, 5:15minutes, 6: 60minutes)
r osd time!	Read OSD time out
s osd time 1!	Set OSD time out (1: 5seconds, 2: 10seconds,3: 15seconds , 4: 20seconds, 5: 25seconds , 6: 30seconds )

Web GUI Control

The switch can be controlled via a Web browser, which contains General, Setup and Network Settings. After the active Ethernet link with a RJ45 cable is connected, the IP address is entered in the Web browser. If the IP address is unknown, there are two methods to obtain the IP address.

1. Obtain the IP address and port number via the information from the MENU-> Network OSD using the remote control.

2. Obtain the IP address and port number via the RS-232 Control software.

For example, the obtained IP address is 192.168.1.100. Input **http://192.168.1.100** in the address bar of the web browser.

1) General

General Video Audio Network Advanced 5x1 Presentation Switcher

**INPUT**

Audio Emb Auto Switch OFF

HDMI 1 HDMI 2 HDMI 3 DP VGA

**OUTPUT**

Resolution 1920x1080@60 Aspect Ratio 16 : 9

**EDID/HDCP**

Set EDID EDID 1.4 Set HDCP HDCP 1.4

2) Video

General Video Audio Network Advanced 5x1 Presentation Switcher

**Picture**

Contrast 50 Brightness 50 Color 30 Sharpness 10

**VGA**

Auto Adjust

H Position 0 V Position 0 Clock 0 Phase 0

### 3) Audio

General Video **Audio** Network Advanced 5x1 Presentation Switcher

#### Volume

Audio Volume 32  
Mute

MIC Volume 25  
Mute

#### Mic Mixer

Mixer **ON** AUTO OFF

Audio Volume: 16 Set  
AudioVol:16

Fade in time: 1000 ms Set  
Time:1000

Fade out time: 1000 ms Set  
Time:1000

### 4) Network

General Video Audio **Network** Advanced 5x1 Presentation Switcher

#### Network Configuration

Static  DHCP  Status

IP 192.168.2.229

Subnet 255.255.252.0 Set

Gateway 192.168.1.1

MAC 00:1c:91:03:80:01

port 8000 Set

#### Status Log

```
DHCP: ON  
IP: 192.168.2.229  
Subnet: 255.255.252.0  
Gateway: 192.168.1.1  
Port: 8000  
MAC: 00:1c:91:03:80:01
```

5) Advanced

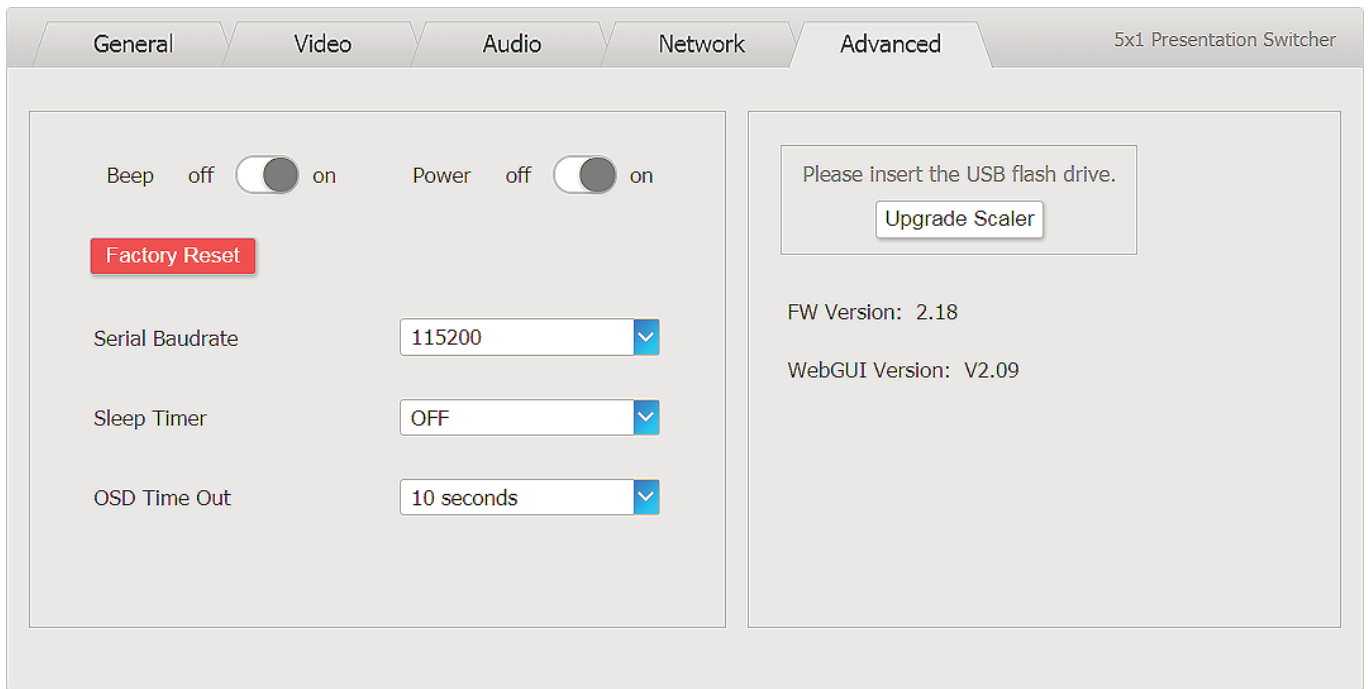

HDBT Receiver

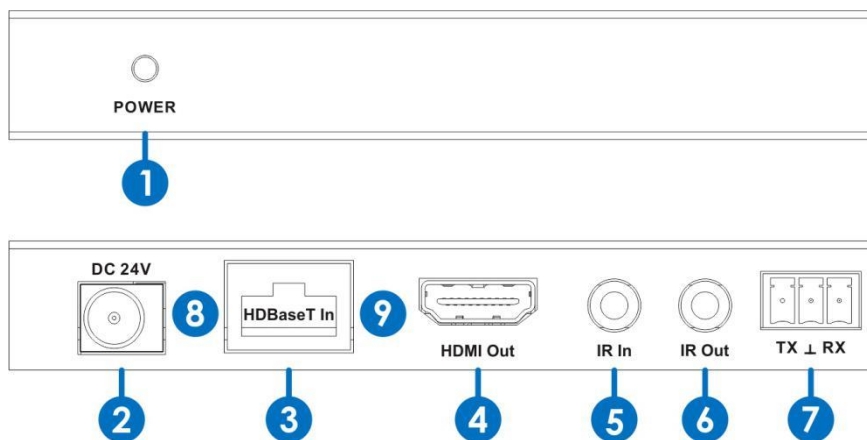

1. **POWER:** This LED illuminates when the device is powered
2. **DC 24V:** Not needed if using PoH remote power from transmitter
3. **HDBaseT IN:** Connect from the transmitters HDBaseT port with a network cable
4. **HDMI OUT:** HDMI output port for connection to the display device.
5. **IR IN:** IR Receiver. Connect with included cable.
6. **IR OUT:** IR Transmitter. Connect with included cable.
7. **RS-232:** Phoenix jack, provides Serial port control signal from receiver or to receiver.
8. **Connection Signal Indicator Lamp**  
 ※Illuminated: The Transmitter and Receiver have a good connections status.  
 ※Flashing: The Transmitter and Receiver have a poor connections status.  
 ※Off: The Transmitter and Receiver are not connected.
9. **Data Signal Indicator Lamp**  
 ※Illuminated: The HDMI signal has HDCP.  
 ※Flashing: The HDMI signal has no HDCP.  
 ※Off: No HDMI signal

## **CE/FCC Statement**

---

### ***CE Certification***

LINDY declares that this equipment complies with relevant European CE requirements.

### ***CE Konformitätserklärung***

LINDY erklärt, dass dieses Equipment den europäischen CE-Anforderungen entspricht

### ***UKCA Certification***

LINDY declares that this equipment complies with relevant UKCA requirements.

### ***FCC Certification***

This equipment has been tested and found to comply with the limits for a Class B digital device, pursuant to part 15 of the FCC Rules. These limits are designed to provide reasonable protection against harmful interference in a residential installation.

You are cautioned that changes or modification not expressly approved by the party responsible for compliance could void your authority to operate the equipment.

This device complies with part 15 of the FCC Rules.

Operation is subject to the following two conditions:

1. This device may not cause harmful interference, and
2. This device must accept any interference received, including interference that may cause undesired operation.

The enclosed power supply has passed Safety test requirements, conforming to the US American versions of the international Standard IEC 60950-1 or 60065 or 62368-1.

---

### **LINDY Herstellergarantie – Hinweis für Kunden in Deutschland**

LINDY gewährt für dieses Produkt über die gesetzliche Regelung in Deutschland hinaus eine zweijährige Herstellergarantie ab Kaufdatum. Die detaillierten Bedingungen dieser Garantie finden Sie auf der LINDY Website aufgelistet bei den AGBs.

---

#### **Hersteller / Manufacturer (EU):**

LINDY-Elektronik GmbH  
Markircher Str. 20  
68229 Mannheim  
Germany  
Email: info@lindy.com , T: +49 (0)621 470050

#### **Manufacturer (UK):**

LINDY Electronics Ltd  
Sadler Forster Way  
Stockton-on-Tees, TS17 9JY  
England  
sales@lindy.co.uk, T: +44 (0)1642 754000

## Recycling Information

---



### WEEE (Waste of Electrical and Electronic Equipment), Recycling of Electronic Products

#### Europe, United Kingdom

In 2006 the European Union introduced regulations (WEEE) for the collection and recycling of all waste electrical and electronic equipment. It is no longer allowable to simply throw away electrical and electronic equipment. Instead, these products must enter the recycling process.

Each individual EU member state has implemented the WEEE regulations into national law in slightly different ways. Please follow your national law when you want to dispose of any electrical or electronic products. More details can be obtained from your national WEEE recycling agency.

#### **Battery Remark:**

Do not put empty batteries in your domestic waste bin as they will not be recycled. Empty batteries can be returned for recycling at our trade counter or at your local household recycling centre.

The raw materials enclosed in batteries such as Zinc, Iron and Nickel can be reused to a very large proportion. The recycling of batteries and disused/obsolete electronic equipment is one of the most efficient environment protection actions you can easily take.

#### Germany / Deutschland

#### Rücknahme Elektroschrott und Batterie-Entsorgung

Die Europäische Union hat mit der WEEE Richtlinie Regelungen für die Verschrottung und das Recycling von Elektro- und Elektronikprodukten geschaffen. Diese wurden im Elektro- und Elektronikgerätegesetz – ElektroG in deutsches Recht umgesetzt. Das Entsorgen von Elektro- und Elektronikgeräten über die Hausmülltonne ist verboten! Diese Geräte müssen den Sammel- und Rückgabesystemen zugeführt werden! Dort werden sie kostenlos entgegen genommen. Die Kosten für den weiteren Recyclingprozess übernehmen die Gerätehersteller.

LINDY bietet deutschen Endverbrauchern ein kostenloses Rücknahmesystem an, beachten Sie bitte, dass Batterien und Akkus den Produkten vor der Rückgabe an das Rücknahmesystem entnommen werden müssen und über die Sammel- und Rückgabesysteme für Batterien separat entsorgt werden müssen. Ausführliche Informationen zu diesen Themen finden Sie stets aktuell auf der LINDY Webseite im Fußbereich.

#### France

En 2006, l'union Européenne a introduit la nouvelle réglementation (DEEE) pour le recyclage de tout équipement électrique et électronique.

Chaque Etat membre de l' Union Européenne a mis en application la nouvelle réglementation DEEE de manières légèrement différentes. Veuillez suivre le décret d'application correspondant à l'élimination des déchets électriques ou électroniques de votre pays.

#### **Remarque sur les piles et batteries**

En tant que consommateur final, vous êtes tenus de restituer toutes les piles et batteries usagées. Il est clairement interdit de les jeter avec les ordures ménagères ! Les piles et batteries contenant des substances nocives sont marquées par le symbole ci-dessus. Vous pouvez déposer gratuitement vos piles ou batteries usagées dans les centres de collecte de votre commune, dans nos succursales ou dans tous les points de vente de piles ou batteries. Vous respecterez ainsi la loi et contribuerez à la protection de l'environnement !

#### Italy

Nel 2006 l'unione europea ha introdotto regolamentazioni (WEEE) per la raccolta e il riciclo di apparecchi elettrici ed elettronici. Non è più consentito semplicemente gettare queste apparecchiature, devono essere riciclate. Ogni stato membro dell' EU ha tramutato le direttive WEEE in leggi statali in varie misure. Fare riferimento alle leggi del proprio Stato quando si dispone di un apparecchio elettrico o elettronico.

Per ulteriori dettagli fare riferimento alla direttiva WEEE sul riciclaggio del proprio Stato.

LINDY No 38281



Tested to comply with  
FCC standards.  
For home and office use.

2<sup>nd</sup> Edition, January 2021

[www.lindy.com](http://www.lindy.com)